

CREATING LIGHT

30 LIGHT·POINT
ANNIVERSARY

LIGHT·POINT®
C O P E N H A G E N



CREATING LIGHT

Through our luminaires, we go beyond function, transcending into the realm of Creating Light, illuminating spaces with brilliance, evoking emotions, and elevating experiences.

**Here's to at least
seven years' peace
of mind**

LIGHT-POINT guarantees you the highest quality in the manufacturing of lighting, which gives you greater value for longer. All products come with a seven-year warranty.



7
YEARS
WARRANTY

CONTENTS

INDEX	8
-------	---

INTRO	10
-------	----

THE COLLECTIONS

AURA	14
------	----

BLADE	24
-------	----

COMPACT	36
---------	----

COSMO	40
-------	----

CUBE	44
------	----

DARK	50
------	----

DELI	60
------	----

DROP	64
------	----

EDGE	72
------	----

FOCUS	84
-------	----

INLAY	92
-------	----

LANTERN	110
---------	-----

LINEA	114
-------	-----

MIRAGE	120
--------	-----

OPTIC OUT	128
-----------	-----

ORBIT	132
-------	-----

RAW	146
RØRHAT	150
SERIOUS	162
SHADOW	166
SKY	170
SLIM	174
SOHO	180
SOLO	188
SPIRIT	192
STRIPE	200
SURFACE	210
VANTAGE	214
ZERO	220
DOWNLIGHTS	
ANGLE	234
CURVE	238
GHOST	242
MIRAGE	246
OPTIC IN	250
GENERAL TERMS	254

INDEX

ACCESSORIES



CEILING BASE L
page 70 + 230



CEILING BASE Ø
page 70 + 230

CEILING / DOWNLIGHTS



ANGLE
page 234



AURA C
page 14



BLADE C1
page 24



COSMO
page 40



CURVE
page 238



FOCUS
page 84



GHOST
page 242



INLAY
page 92



MIRAGE
page 246



OPTIC IN
page 250



OPTIC OUT
page 128



RAW
page 146



SHADOW
page 166



SKY
page 170



SOLO
page 188



STRIPE C/W
page 200



SURFACE
page 210



VANTAGE
page 214

FLOOR LAMPS



BLADE
page 24



DARK F1
page 50



INLAY
page 92



ORBIT FLOOR
page 132



SPIRIT F1
page 192

GARDEN STANDS



CUBE STAND
page 44



LANTERN G
page 110



MIRAGE STAND
page 120



ORBIT STAND
page 132



RØRHAT STAND
page 150

PENDANTS



DROP
page 64



BLADE S
page 24



EDGE LINEAR
page 72



EDGE ROUND
page 72



INLAY S3
page 92



INLAY S900
page 92



INLAY S1250
page 92



SLIM
page 174



SPIRIT S
page 192



STRIPE S
page 200



ZERO S
page 220

TABLE LAMPS



BLADE T2
page 24



DARK T
page 50



INLAY T2
page 92



SPIRIT T1
page 192

WALL LAMPS



AURA W
page 14



COMPACT
page 36



CUBE
page 44



DELI
page 60



FOCUS GALLERY
page 84



INLAY W1
page 92



INLAY
page 92



LANTERN W
page 110



LINEA W1
page 114



MIRAGE W
page 120



ORBIT W
page 132



RØRHAT
page 150



SERIOUS
page 162



SHADOW
page 166



SOHO
page 180



STRIPE C/W
page 200



SURFACE
page 210



ZERO W
page 220

INTRO

30 Years of Design History

After three decades in the fast-paced yet endlessly inspiring world of design, it's a pleasure to pause and reflect on all that these years have brought. It all began in 1995, when I made the bold decision to become my own boss. Lighting became my passion, my profession, and the foundation for a business I hoped would grow into something meaningful.

Since then, time has flown by. Design after design has come to life, and along the way, a few have even become modern classics. With a playful and curious approach, I've explored new ideas, challenged norms, and helped shape a collection that reflects both creativity and purpose.

It's been anything but boring—30 years filled with exciting projects, new product launches, and steady expansion.



Every piece we've created has been a personal expression—creatively and in terms of design. My goal was never to build a brand for the sake of branding, but rather to see people embrace and enjoy our products in their homes, workplaces, and everyday lives. That has been the greatest reward.

Today, we proudly design, produce, and sell lighting to an international audience, and over the years, we've been honored with numerous design awards. Yet the core values remain unchanged since 1995. Curiosity and experimentation are still at the heart of everything we do. And I continue to take great joy in designing, innovating, and growing our creative universe.

Here's to the next chapter.
Enjoy!

Ronni Gol
CEO / Founder / Entrepreneur

THE COLLECTIONS





AURA Collection

AURA is an award-winning collection based on LIGHT-POINT's characteristic design style with its clean, calm lines. At the same time, round curves lend AURA an aesthetic softness. The collection consists of ceiling and wall lights. AURA Ceiling is available with two and three light sources that can rotate on their own axis, making them super flexible. AURA Wall is available in four lengths. W3 and W4 are particularly suitable for hanging above a bathroom mirror.



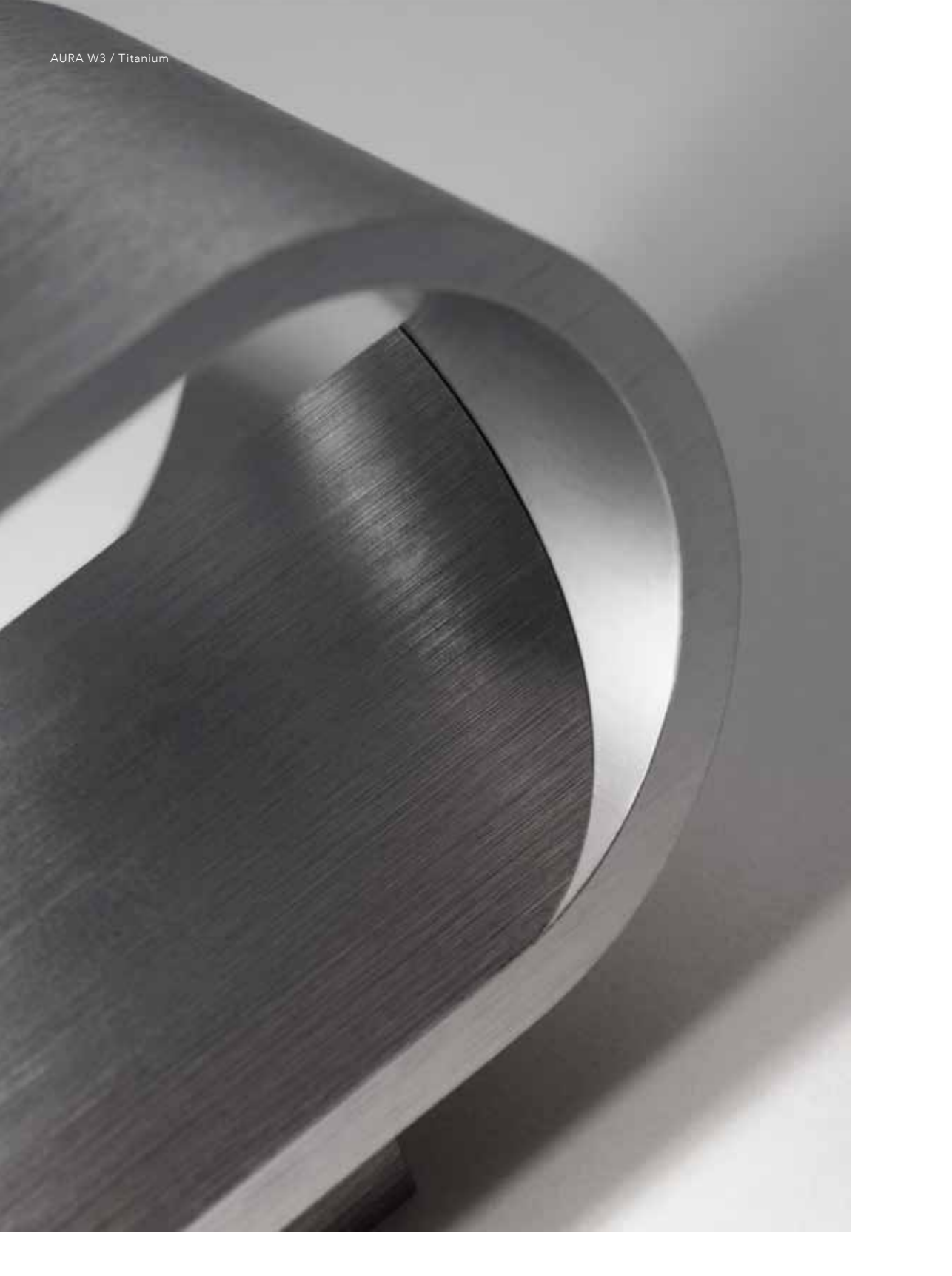



AURA W3 / Titanium
SOLO 1 / Titanium

AURA C

Product Specs

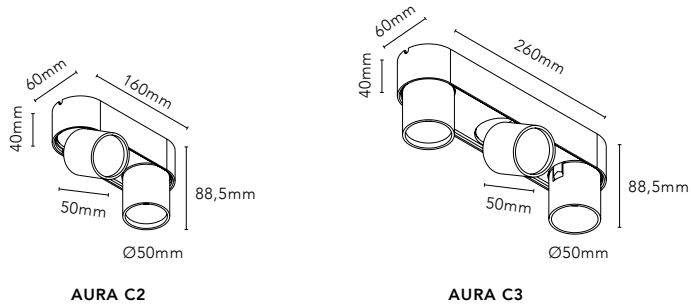

Designer

Nital Patel

Award



Technical Info

LED | DIMMABLE | IP20 | INDOOR USE | SWITCH TUNE

SWITCH TUNE gives you the option to choose between 2700K or 3000K before installing the lamp.

Colour Options

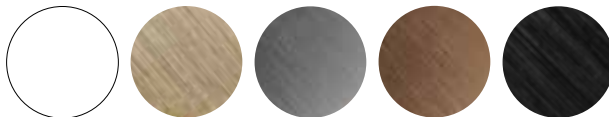

*Anodized surfaces may vary $\pm 10\%$.

WHITE

BRASS*

TITANIUM*

ROSE GOLD*

CARBON BLACK*



AURA W

Product Specs

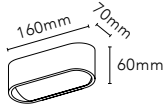

AURA W1

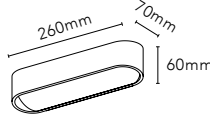

AURA W2

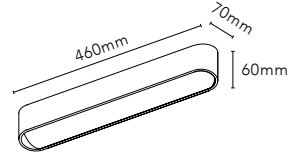

AURA W3

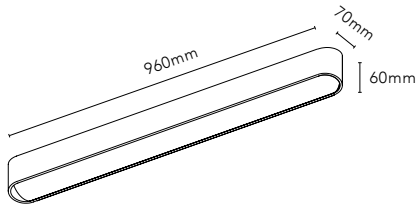

AURA W4

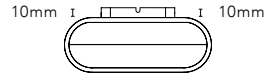

General Measurements

All four sizes

Designer

Nital Patel

Award



Technical Info

LED | DIMMABLE | IP20 | INDOOR USE | SWITCH TUNE

SWITCH TUNE gives you the option to choose between 2700K or 3000K before installing the lamp.

All AURA wall lamps are spaced 10mm from the wall.

Colour Options

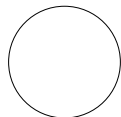

WHITE**



BLACK



BRASS*

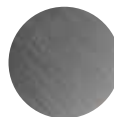

TITANIUM*



ROSE GOLD*

*Anodized surfaces may vary $\pm 10\%$.

**AURA W4 available in white only.

AURA W2 / Black



AURA W3 / Black





AURA W1

6W LED | 230V | IP20 | CRI >90
Lumen 660lm (nominal)

BRASS 2700/3000K	270964
TITANIUM 2700/3000K	270963
ROSE GOLD 2700/3000K	270962
WHITE 2700/3000K	270960
BLACK 2700/3000K	270961

SWITCH  TUNE TM



AURA W2

15W LED | 230V | IP20 | CRI >90
Lumen 1540lm (nominal)

BRASS 2700/3000K	270974
TITANIUM 2700/3000K	270973
ROSE GOLD 2700/3000K	270972
WHITE 2700/3000K	270970
BLACK 2700/3000K	270971

SWITCH  TUNE TM



AURA W3

18W LED | 230V | IP20 | CRI >90
Lumen 1980lm (nominal)

BRASS 2700/3000K	270984
TITANIUM 2700/3000K	270983
ROSE GOLD 2700/3000K	270982
WHITE 2700/3000K	270980
BLACK 2700/3000K	270981

SWITCH  TUNE TM



AURA W4

32W LED | 230V | IP20 | CRI >90
Lumen 3520lm (nominal)

WHITE 2700/3000	281090
-----------------	--------

SWITCH  TUNE TM





LIGHT·POINT



AURA C2

2x7W LED | 230V | IP20 | CRI >90
Lumen 1540lm (nominal)

BRASS 2700/3000K	270994
TITANIUM 2700/3000K	270993
ROSE GOLD 2700/3000K	270992
CARBON BLACK 2700/3000K	270991
WHITE 2700/3000K	270990

SWITCH  TUNE™



AURA C3

3x7W LED | 230V | IP20 | CRI >90
Lumen 2310lm (nominal)

BRASS 2700/3000K	270999
TITANIUM 2700/3000K	270998
ROSE GOLD 2700/3000K	270997
CARBON BLACK 2700/3000K	270996
WHITE 2700/3000K	270995

SWITCH  TUNE™



BLADE Collection

BLADE is based on precision, geometry and clean lines. Comprising two cylinders connected by a moveable, linear core, its integrated yet hidden functionalities play an important role. All hinges and cables are integrated into the design and so are invisible. Every element has been stripped down to its essential function and is there for a reason.

When you tilt the arm and rotate the shade, BLADE casts a beautiful light, regardless of where it's positioned. It's a timeless collection that celebrates the high quality of its material, emphasised by its slender, elegant silhouette. With its pure design and sleek form, it's sure to add style to any room.

The collection encompasses table, floor, pendant and wall lights. All lamps come with LEDs as well as an optical glass providing a wide, glare-free light, and are ideally suited for both the residential and hospitality sectors.

BLADE collection is the result of the exclusive collaboration between LIGHT-POINT and the internationally recognized premium design consultancy, Studio F. A. Porsche. BLADE won the prestigious iF DESIGN AWARD, 2023.



BLADE Collection



BLADE T1 / Matt Black - Satin Gold



Ferdinand Alexander Porsche





BLADE collection

LIGHT-POINT | DESIGN BY STUDIO F. A. PORSCHE

In 2018, LIGHT-POINT devised a global growth strategy centred on the Premium Design to position the brand in a class of its own. In the last four years, LIGHT-POINT has grown significantly and its collections, developed by its in-house design team, have garnered many international accolades.

In 2021, LIGHT-POINT became a member of an exclusive group of companies to partner with the internationally recognised premium design consultancy, Studio F. A. Porsche. The strategic vision of this partnership is to enhance the premium design quality of LIGHT-POINT's product collection.

For the first two design collections, BLADE and INLAY, Studio F. A. Porsche dreamt up an innovative yet contemporary lighting collection that expresses its design DNA.



BLADE
Collection





Design by
STUDIO F·A·PORSCHE

BLADE C1 / Matt Black / Satin Gold



Design by
STUDIO F·A·PORSCHE

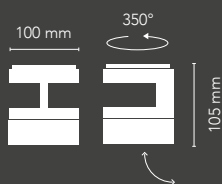

BLADE C1 SLIM

8,4W LED - 230V - IP20 - 2700/3000K-

CRI: > 90 - Dimmable - Material: Aluminium/ Glass

Lumen 924lm (nominal)

SWITCH  TUNE™



MATT BLACK/ SATIN GOLD 900240
MATT BLACK/ SATIN SILVER 900241

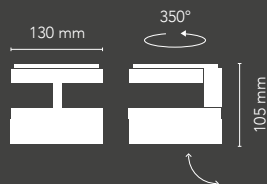

BLADE C1+ SLIM

11W LED - 230V - IP20 - 2700/3000K

CRI: > 90 - Dimmable - Material: Aluminium/ Glass

Lumen 1463lm (nominal)

SWITCH  TUNE™



MATT BLACK/ SATIN GOLD 900250
MATT BLACK/ SATIN SILVER 900251

BLADE Collection

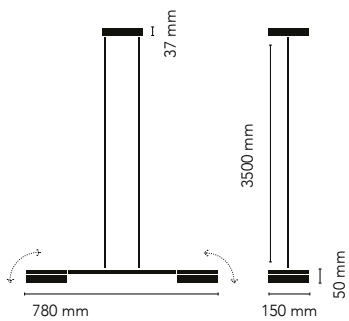

BLADE S2 SLIM

2x16W LED - 230V - IP20 - 2700-6500K

CRI: > 90 - Dimmable - Material: Aluminium/ Glass

Lumen 3520lm (nominal)

SMART TUNE™



MATT BLACK/ SATIN GOLD	900200
MATT BLACK/ SATIN SILVER	900201



BLADE collection



Design by
STUDIO F·A·PORSCHE

BLADE Collection

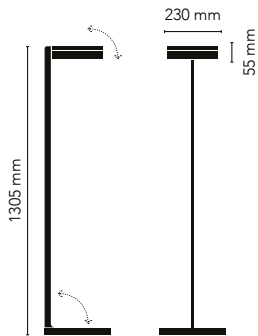

BLADE F1 SLIM

12,5W LED - 230V - IP20 - 2700/3000K

CRI: > 90 - Dimmable - Material: Aluminium/ Glass

Lumen 1375lm (nominal)

SWITCH  TUNE™



MATT BLACK/ SATIN GOLD	900160
MATT BLACK/ SATIN SILVER	900161

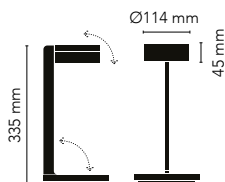

BLADE T1 SLIM

9W LED - 230V - IP20 - 2700/3000K

CRI: > 90 - Dimmable - Material: Aluminium/ Glass

Lumen 990lm (nominal)

SWITCH  TUNE™



MATT BLACK/ SATIN GOLD	900120
MATT BLACK/ SATIN SILVER	900121

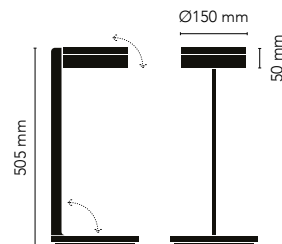

BLADE T2 SLIM

12,5W LED - 230V - IP20 - 2700/3000K

CRI: > 90 - Dimmable - Material: Aluminium/ Glass

Lumen 1375lm (nominal)

SWITCH  TUNE™



MATT BLACK/ SATIN GOLD	900130
MATT BLACK/ SATIN SILVER	900131

COMPACT

Product Specs

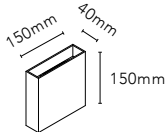

COMPACT UP/DOWN W1

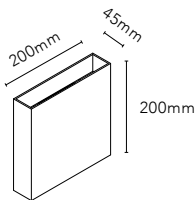

COMPACT UP/DOWN W2

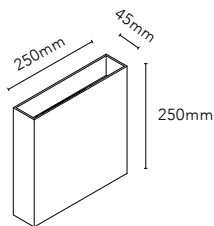

COMPACT UP/DOWN W3

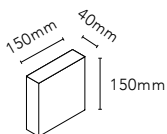

COMPACT DOWN W1

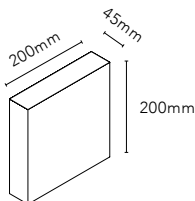

COMPACT DOWN W2

Designer

Ronni Gol

Technical Info

LED | DIMMABLE | IP54 | INDOOR USE | OUTDOOR USE | SWITCH TUNE*

*SWITCH TUNE is only available for COMPACT UP/DOWN W1 and W2.

SWITCH TUNE gives you the option to choose between 2700K or 3000K before installing the lamp.*

Colour Options

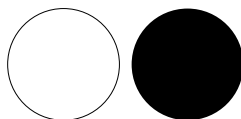

*COMPACT DOWN available in black only.

WHITE

BLACK*





COMPACT UP/DOWN W1

2x3W LED | 230V | IP54 | CRI >90
Lumen 380lm (3000K) / 354lm (2700K)

WHITE 2700/3000K	270003
BLACK 2700/3000K	270004

SWITCH  TUNE™



COMPACT UP/DOWN W2

2x6W LED | 230V | IP54 | CRI >90
Lumen 515lm (3000K) / 479lm (2700K)

WHITE 2700/3000K	270013
BLACK 2700/3000K	270014

SWITCH  TUNE™



COMPACT UP/DOWN W3

2x6W LED | 230V | IP54 | CRI >90
Lumen 645lm

BLACK 3000K	256338
-------------	--------



COMPACT DOWN W1

3W LED | 230V | IP54 | CRI >90
Lumen 190lm

BLACK 3000K	256341
-------------	--------



COMPACT DOWN W2

6W LED | 230V | IP54 | CRI >90
Lumen 290lm

BLACK 3000K	256344
-------------	--------



COSMO

Product Specs

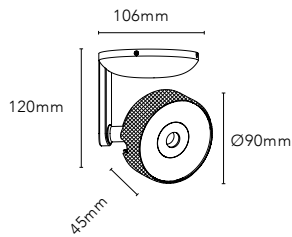

COSMO C1

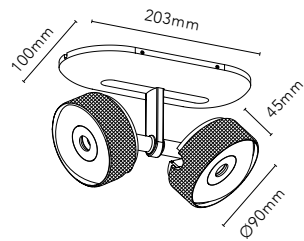

COSMO C2

Designer

Nital Patel

Technical Info

LED | DIMMABLE | IP20 | INDOOR USE | SWITCH TUNE*

SWITCH TUNE gives you the option to choose between 2700K or 3000K before installing the lamp.*

*SWITCH TUNE is only available for COSMO C1 in Brass and White and COSMO C2 in Brass.

The spot can rotate 350 degrees, providing maximum light versatility compared to a typical fixed spot.

Colour Options

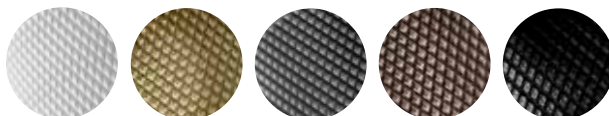

*Anodized surfaces may vary $\pm 10\%$.

WHITE

BRASS*

TITANIUM*

ROSE GOLD*

CARBON BLACK*





COSMO C1

8W LED | 230V | IP20 | CRI >90
Lumen 726lm (nominal)

ROSE GOLD 2700K/3000KK	271072
TITANIUM 2700K/3000K	271073
BRASS 2700/3000K	271074
WHITE 2700/3000K	271070

SWITCH TUNE™

CARBON BLACK 2700K	271001
--------------------	--------



COSMO C2

2x8W LED | 230V | IP20 | CRI >90 Lumen
1450lm (nominal)

ROSE GOLD 2700K/3000K	271077
CARBON BLACK 2700K/3000K	271076
TITANIUM 2700/3000K	271078
BRASS 2700/3000K	271079

SWITCH TUNE™

WHITE 2700K	271010
-------------	--------



CUBE Collection



CUBE / Black



CUBE STAND / Black





CUBE / Black

TIMELESS, BOLD & SCULPTURAL

CUBE is an outdoor lamp that is both classic and innovative at the same time. Its sharp, stringent design is entirely minimalist and understated, yet the lamp makes a design statement with sculptural qualities.

CUBE is available in black and a new rust version. The rust surface adds a more rustic and industrial look without being dominant. The reddish-brown hue is perfect for adding warmth to walls and facades, blending seamlessly into natural surroundings.

CUBE / CUBE STAND

Product Specs

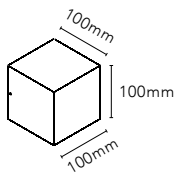

CUBE DOWN

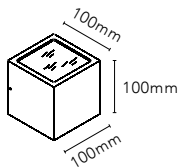

CUBE

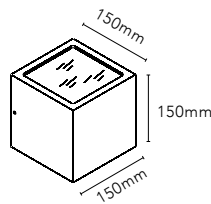

CUBE XL + DOWN

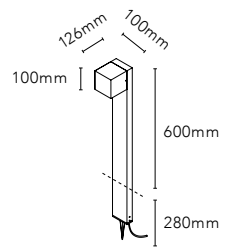

CUBE STAND

Designer

Ronni Gol

Technical Info

LED | DIMMABLE | IP54 | INDOOR USE | OUTDOOR USE

The conic light beams from the CUBE and CUBE XL can be adjusted independently according to preference.

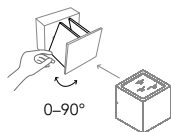

Colour Options

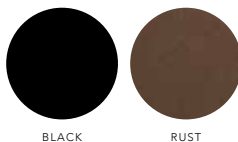





CUBE

2x3.2W LED | 230V | IP54 | CRI >90 |
Lumen 440lm

BLACK ^{3000K}	256182
RUST ^{3000K}	256183



CUBE XL

2x7.2W LED | 230V | IP54 | CRI >90 |
Lumen 860lm

BLACK ^{3000K}	256187
RUST ^{3000K}	256188



CUBE DOWN

3.2W LED | 230V | IP54 | CRI >90 |
Lumen 190lm

BLACK ^{3000K}	256192
------------------------	--------



CUBE XL DOWN

7.2W LED | 230V | IP54 | CRI >90 |
Lumen 792lm

BLACK ^{3000K}	256197
------------------------	--------



CUBE STAND

Prices are incl. lamp.
Maximum height over ground: 600mm.

LAMP + STAND	256192 + 256107
--------------	-----------------





DARK Collection

Beneath the simple look of the DARK collection, thoughtful details lie waiting to be discovered. This lamp is easy to use and fits into any room in the home. The flexible head makes it easy to direct the light in the desired direction, and the upper part of the arm can be adjusted, making it the ideal light for reading and working. DARK is functional both on a desk and next to a chair or sofa, where it casts a soft and cosy glow. This also goes for the wall version, which can be used as a bedside lamp.

The lamp has an innovative on/off switch with a built-in dimming function, so you can easily and elegantly adjust the brightness by keeping your finger on the button. The IF Design Award-winning series consists of two table lamps, a floor lamp, and a wall lamp.



DARK T

Product Specs

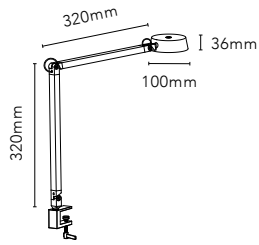

DARK T1

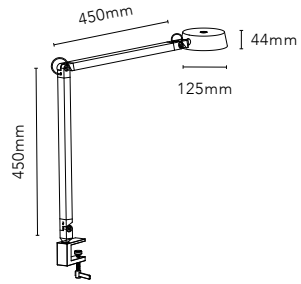

DARK T2

Designer

Nital Patel

Award



Technical Info

LED | DIMMABLE | IP20 | INDOOR USE

All lamps in the DARK collection feature a touch button.



Colour Options



BRASS*



TITANIUM*



ROSE GOLD*

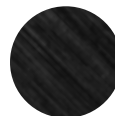

CARBON BLACK*

*Anodized surfaces may vary $\pm 10\%$.



DARK T2 / Titanium

DARK F1 / Carbon Black



DARK F1

Product Specs

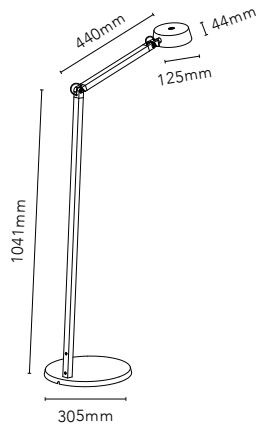

DARKT F1

Designer

Nital Patel

Award



Technical Info

LED | DIMMABLE | IP20 | INDOOR USE

All lamps in the DARK collection feature a touch button.



Colour Options

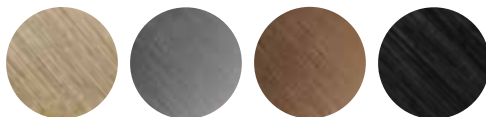

*Anodized surfaces may vary $\pm 10\%$.

BRASS*

TITANIUM*

ROSE GOLD*

CARBON BLACK*

DARK ACCESSORIES

Product Specs

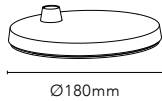

DARK BASE FOR T1

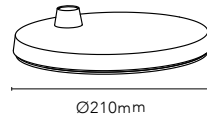

DARK BASE FOR T2

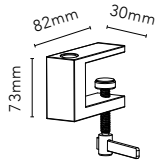

DARK CLAMP FOR T1/T2

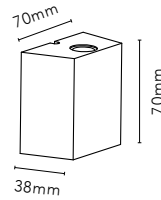

DARK WALL MOUNT

Designer

Nital Patel

Award



Colour Options



*Anodized surfaces may vary $\pm 10\%$.

BLACK

BRASS*

TITANIUM*

ROSE GOLD*

CARBON BLACK*





DARK F1

15W LED | 230V | IP20 | CRI >90
Lumen 910lm (nominal)

BRASS 3000K	271124
TITANIUM 3000K	271123
ROSE GOLD 3000K	271122
CARBON BLACK 3000K	271121



DARK T1

10W LED | 230V | IP20 | CRI >90
Lumen 780lm (nominal)

BRASS 3000K	271134
TITANIUM 3000K	271133
ROSE GOLD 3000K	271132
CARBON BLACK 3000K	271131



DARK T2

15W LED | 230V | IP20 | CRI >90
Lumen 1050lm (nominal)

BRASS 3000K	271144
TITANIUM 3000K	271143
ROSE GOLD 3000K	271142
CARBON BLACK 3000K	271141



DARK BASE FOR T1

BLACK

271161



DARK BASE FOR T2

BLACK

271163



DARK CLAMP FOR T1+T2

BLACK

271171



DARK WALL MOUNT

BRASS	271184
TITANIUM	271183
ROSE GOLD	271182
CARBON BLACK	271181



DELI

Product Specs

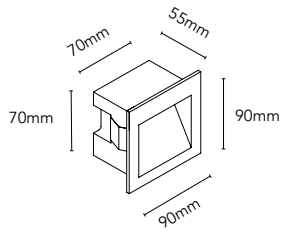

DELI 1

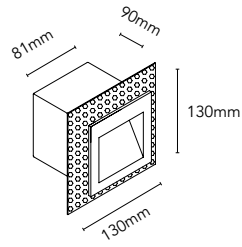

DELI 1 mounting box
(Included)

Designer

Ronni Gol

Technical Info

LED | DIMMABLE | IP54 | INDOOR USE | OUTDOOR USE

Colour Options

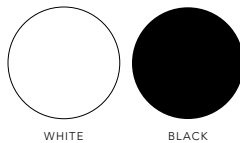

WHITE

BLACK



DELI 1 / White



DELI

4.5W LED | 230V | IP54 | CRI >90 |
Lumen 160lm

WHITE 3000K	260880
BLACK 3000K	260881





DROP Collection



DROP / Rose Gold





DROP / Rose Gold

LIKE DROPS DRIPPING FROM THE CEILING!

DROP is an elegant, slim ceiling pendant that can hang alone or in clusters – your imagination is the limit. You can create a big, spectacular installation in a space like a hall, or hang a smaller number in a row above a table.

DROP offers pleasant illumination, with small light sources that are deep enough to avoid glare. DROP is available in two lengths.

DROP

Product Specs

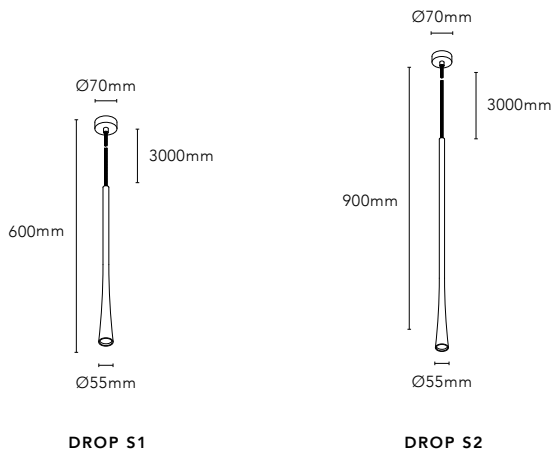

Designer

Ronni Gol

Technical Info

LED | DIMMABLE | IP20 | INDOOR USE |

See additional ceiling bases on page 196.

Colour Options

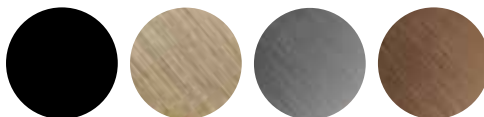

*Anodized surfaces may vary $\pm 10\%$.

BLACK

BRASS*

TITANIUM*

ROSE GOLD*



DROP / Brass



DROP S1

6W LED | 230V | IP20 | CRI >90 |
Lumen 540lm

BRASS ^{2700K}	270484
TITANIUM ^{2700K}	270483
ROSE GOLD ^{2700K}	270482
BLACK ^{3000K}	280261



DROP S2

6W LED | 230V | IP20 | CRI >90 |
Lumen 540lm

BRASS ^{2700K}	270494
TITANIUM ^{2700K}	270493
ROSE GOLD ^{2700K}	270492
BLACK ^{3000K}	280265



DROP / Titanium

DROP CEILING BASES

Product Specs

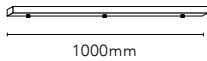

CEILING BASE L1000
3 Pendants

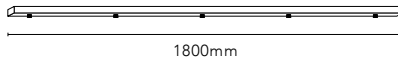

CEILING BASE L1800
5 Pendants

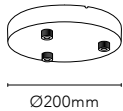

CEILING BASE Ø200
3 Pendants

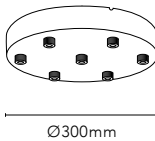

CEILING BASE Ø300
7 Pendants

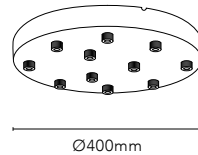

CEILING BASE Ø400
11 Pendants

Designer

LP Design Team

Technical Info

To be combined with the DROP pendant (see page ??) or the ZERO pendant (see page ???).

Colour Options

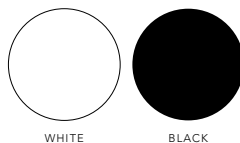



**CEILING BASE L1000
3 PENDANTS**

WHITE

280540



**CEILING BASE L1800
5 PENDANTS**

WHITE
BLACK

280543
280544



CEILING BASE Ø400 / Black / DROP S1 / DROP S2 / Rose Gold



**CEILING BASE Ø200
3 PENDANTS**

WHITE
BLACK

280530
280531



**CEILING BASE Ø300
7 PENDANTS**

WHITE
BLACK

280533
280534



**CEILING BASE Ø400
11 PENDANTS**

WHITE
BLACK

280536
280537

EDGE Collection



EDGE ROUND / Brass





EDGE LINEAR / Brass

CUTTING-EDGE ELEGANCE WITH A SMART TUNE FUNCTION

The name says it all: EDGE. A cutting-edge collection of pendants with edge and character. EDGE is available in a long, slim, linear version and in a circular model. Both are sculptural and sophisticated. The built-in Smart Tune function lets you control and manage the light using either an app on your smartphone or the touchless sensor. This makes it easy to switch your light on or off, adjust the brightness, and change the colour temperature. EDGE Round is ideal for hanging in multiples above a larger dining table.

EDGE Collection



EDGE ROUND / Rose Gold



EDGE LINEAR

Product Specs

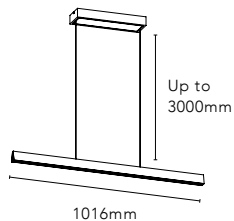

EDGE LINEAR S1000

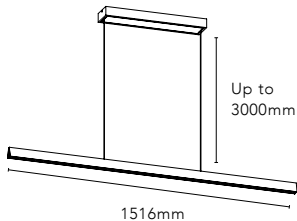

EDGE LINEAR S1500

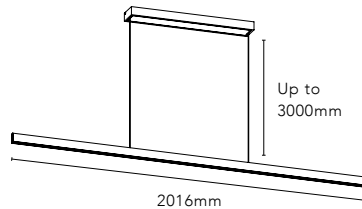

EDGE LINEAR S2000

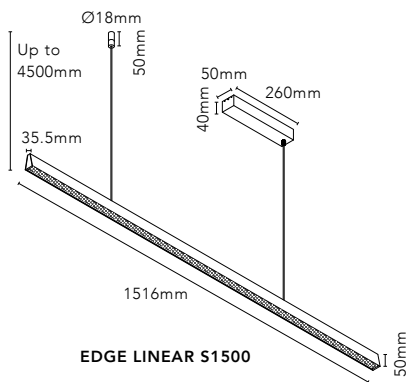

EDGE LINEAR S1500

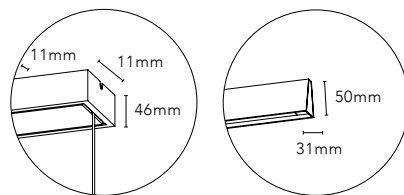

General Measurements
All three sizes

Designer

Nital Patel

Award



Technical Info

LED | DIMMABLE | IP20 | INDOOR USE | SMART TUNE

EDGE LINEAR is dimmable with:
Integrated with LIGHT-POINT SMART TUNE Powered by Casambi,
or LIGHT-POINT SWITCH TUNE.

This product cannot be controlled by external trailing-edge dimmer.

Colour Options

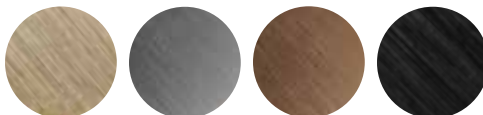

*Anodized surfaces may vary ±10%

BRASS*

TITANIUM*

ROSE GOLD*

CARBON BLACK*



EDGE ROUND





EDGE ROUND

Product Specs

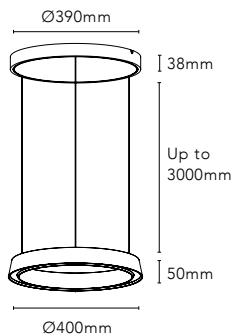

EDGE ROUND Ø400

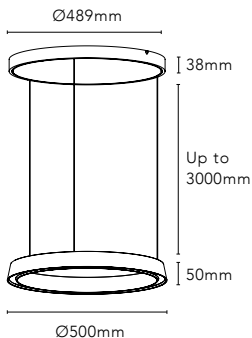

EDGE ROUND Ø500

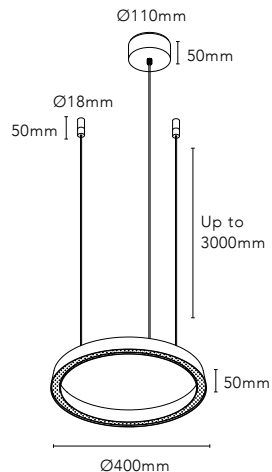

EDGE ROUND Ø400

Designer

Nital Patel

Award



Technical Info

LED | DIMMABLE | IP20 | INDOOR USE | SMART TUNE

EDGE ROUND is dimmable with:
Integrated with LIGHT-POINT SMART TUNE Powered by Casambi,
or LIGHT-POINT SWITCH TUNE.

This product cannot be controlled by external trailing-edge dimmer.

Colour Options

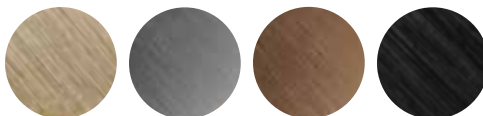

*Anodized surfaces may vary $\pm 10\%$

BRASS*

TITANIUM*

ROSE GOLD*

CARBON BLACK*





EDGE LINEAR S1000

10W+20W LED | 230V | IP20 |
CRI >90 | Lumen 1800lm

BRASS 2700-5000K	270553
TITANIUM 2700-5000K	270555
ROSE GOLD 2700-5000K	270554
CARBON BLACK 2700-5000K	270550



EDGE LINEAR S1500

13W+28W LED | 230V | IP20 |
CRI >90 | Lumen 2700lm

BRASS 2700-5000K	270563
TITANIUM 2700-5000K	270559
ROSE GOLD 2700-5000K	270558
CARBON BLACK 2700-5000K	270560



EDGE LINEAR S2000

22W+44W LED | 230V | IP20 |
CRI >90 | Lumen 3600lm

BRASS 2700-5000K	270566
TITANIUM 2700-5000K	270569
ROSE GOLD 2700-5000K	270568
CARBON BLACK 2700-5000K	270567

SMART TUNE™



SMART TUNE™



SMART TUNE™

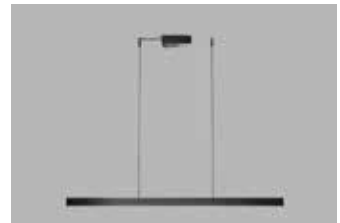

EDGE LINEAR S1500 NEW

10W+20W LED | 230V | IP20 |
CRI >90 | Lumen 1800lm

BRASS 2700-5000K	271500
TITANIUM 2700-5000K	271503
ROSE GOLD 2700-5000K	271502
CARBON BLACK 2700-5000K	271501

SWITCH TUNE™



EDGE ROUND Ø400 NEW

10W+20W LED | 230V | IP20 |
CRI >90 | Lumen 1800lm

BRASS 2700-5000K	271508
TITANIUM 2700-5000K	271511
ROSE GOLD 2700-5000K	271510
CARBON BLACK 2700-5000K	271509

SWITCH  TUNE™



EDGE ROUND Ø500

10W+20W LED | 230V | IP20 |
CRI >90 | Lumen 1800lm

BRASS 2700-5000K	270533
TITANIUM 2700-5000K	270534
ROSE GOLD 2700-5000K	270535
CARBON BLACK 2700-5000K	270530

SMART  TUNE™



EDGE ROUND Ø500

12.5W+24.5W LED | 230V | IP20 |
CRI >90 | Lumen 2220lm

BRASS 2700-5000K	270543
TITANIUM 2700-5000K	270544
ROSE GOLD 2700-5000K	270545
CARBON BLACK 2700-5000K	270540

SMART  TUNE™



FOCUS Collection



FOCUS 2 / Black



FOCUS L900 / Rose Gold





FOCUS 2 / White

PRECISION AND FLEXIBILITY

A round spotlight in a square base. FOCUS is a ceiling spotlight that can rotate 350 degrees, ensuring maximum flexibility and focused light.

It's perfect for highlighting artwork, but it also works really well as ceiling lighting if you want to emphasise something special in your interior design. FOCUS can also be directed vertically into the floor to create exciting effects in a room.

FOCUS / FOCUS L

Product Specs

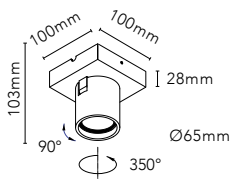

FOCUS 1

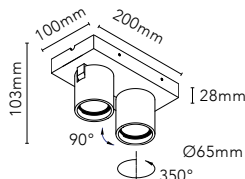

FOCUS 2

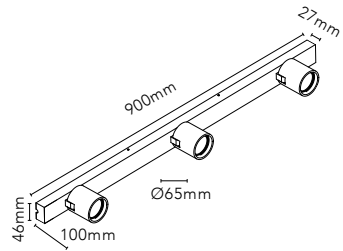

FOCUS L900

Designer

Ronni Gol

Technical Info

LED | DIMMABLE | IP20 | INDOOR USE

Colour Options



*Anodized surfaces may vary $\pm 10\%$

WHITE

BLACK

BRASS*

ROSE GOLD*

FOCUS 2 / Brass



FOCUS L900 / Brass





FOCUS GALLERY / FOCUS TRACK

Product Specs

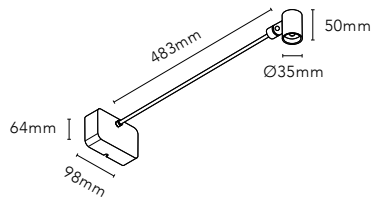

FOCUS GALLERY

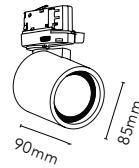

FOCUS+ TRACK 3-PHASE

Designer

Ronni Gol

Technical Info

LED | DIMMABLE | IP20 | INDOOR USE |

FOCUS TRACK includes a 3-phase track adapter. Suitable for 3-phase track.

Colour Options

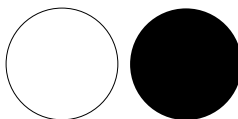

WHITE

BLACK



FOCUS 1

6W LED | 230V | IP20 | CRI >90
Lumen 375lm (3000K) / 349lm (2700K)

BRASS 2700K	270023
ROSE GOLD 27000K	270022
BRASS 3000K	261625
ROSE GOLD 3000K	261624

SWITCH TUNE™



FOCUS 1

6,5W LED | 230V | IP20 | CRI >90
Lumen 715lm (3000K) / 695lm (2700K)

WHITE 2700K/3000K	290113
BLACK 2700K/3000K	290112

SWITCH TUNE™



FOCUS 2

2x6W LED | 230V | IP20 | CRI >90
Lumen 750lm (3000K) / 695lm (2700K)

ROSE GOLD 27000K	270032
BRASS 3000K	261628
ROSE GOLD 3000K	261627



FOCUS 2

2x12,6W LED | 230V | IP20 | CRI >90
Lumen 1386lm

WHITE 2700K/3000K	290117
BLACK 2700K/3000K	290116

SWITCH TUNE™



FOCUS L900

3x18W LED | 230V | IP20 | CRI >90 |
Lumen 1980lm

WHITE 2700K/3000K	290121
BLACK 2700K/3000K	290120
BRASS 2700K/3000K	NEW 290122
ROSE GOLD 2700K/3000K	NEW 290123

SWITCH TUNE™



FOCUS GALLERY

5W LED | 230V | IP20 | CRI >90 |
Lumen 450lm (nominal)

WHITE ^{3000K}	261670
BLACK ^{3000K}	261671



FOCUS+ TRACK 3-PHASE

10W LED | 230V | IP20 | CRI >90 |
Lumen 800lm

WHITE ^{3000K}	261654
------------------------	--------



INLAY C1/ Matt Black-Satin Gold

INLAY Collection

INLAY is a design based on one core principle – a straight line – which is its very essence. The collection is supremely minimalist yet highlights the contrasts between similar materials – Matt Black Aluminium combined with Satin Gold or Matt Silver Aluminium.

INLAY is a masterstroke in precision, its design language defined by the interplay between its materials – the result of many hours spent refining it down to every detail.

INLAY is a stylish design with a clean, architectural form, free of superfluous elements. Its linear form casts an even light along the entire length of the lamp, which incorporates Wa touch or a touchless sensor to switch it on or off, and dim the light.

The INLAY collection comprises floor, table, wall and pendant lights. All pendants feature a built-in SMART TUNE solution, allowing you to switch the light on and off and control its colour temperature and brightness, all via the Casambi app.

INLAY collection is the result of the exclusive collaboration between LIGHT-POINT and the internationally recognized premium design consultancy, Studio F. A. Porsche. INLAY won the prestigious RedDot Award, 2023.



INLAY Collection



INLAY S2 / Matt Black-Satin Gold



INLAY S1 / Matt Black-Satin Gold





INLAY LINEAR/ Matt Black-Satin Silver

ONE FINE LINE

“The INLAY concept is a bold statement – it deals with the absence of design at first glance. It’s a remarkable example of the emphasis placed on detail and workmanship. Mastering this fine line has taken courage and been a huge challenge” – Christian Schwamkrug, former Design Director at Studio F. A. Porsche.

INLAY collection won the prestigious RedDot Award, 2023.

INLAY
Collection



Design by
STUDIO F·A·PORSCHE



INLAY C3 / Matt Black-Satin Gold



Design by
STUDIO F·A·PORSCHE

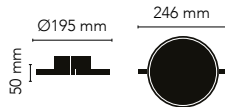

INLAY C1 DISC

12W LED - 230V - IP20 - 2700/3000K

CRI: > 90 - Dimmable - Material: Aluminium/ Acrylic
Lumen 1320lm (nominal)



MATT BLACK/ SATIN GOLD	900000
MATT BLACK/ SATIN SILVER	900001

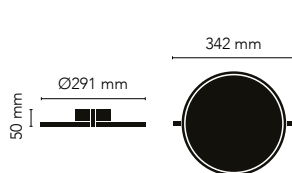

INLAY C2 DISC

18W LED - 230V - IP20 - 2700/3000K

CRI: > 90 - Dimmable - Material: Aluminium/ Acrylic
Lumen 1980lm (nominal)



MATT BLACK/ SATIN GOLD	900010
MATT BLACK/ SATIN SILVER	900011

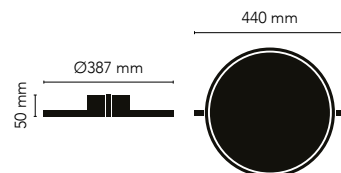

INLAY C3 DISC

25W LED - 230V - IP20 - 2700/3000K

CRI: > 90 - Dimmable - Material: Aluminium/ Acrylic
Lumen 2750lm (nominal)



MATT BLACK/ SATIN GOLD	900020
MATT BLACK/ SATIN SILVER	900021

INLAY S2 / Matt Black-Satin Silver

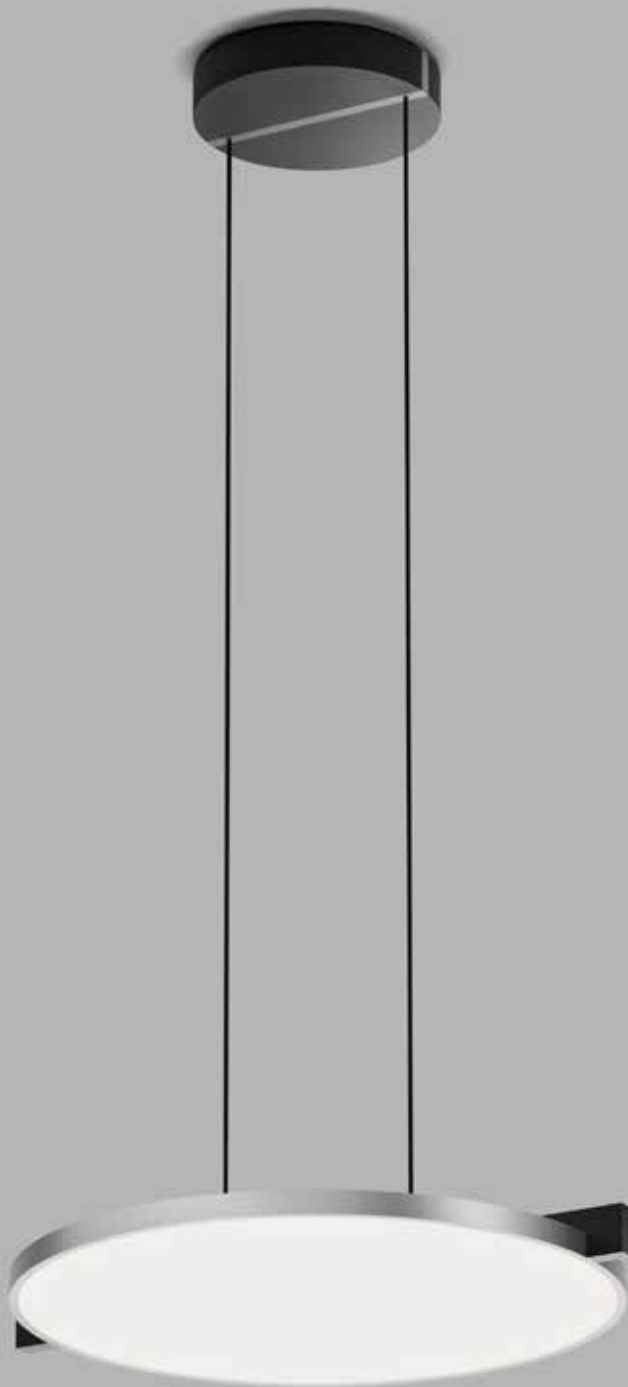

Design by
STUDIO F·A·PORSCHE

INLAY

Product Specs

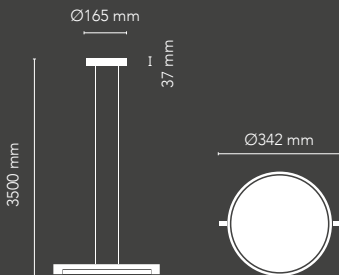

INLAY S2 Ø342 DISC

18W LED - 230V - IP20 - 2700/3000K
CRI: > 90 - Dimmable - Material: Aluminium/ Glass
Lumen 1980lm (nominal)

SWITCH  TUNE™



red dot winner 2023

MATT BLACK/ SATIN GOLD
MATT BLACK/ SATIN SILVER

900026
900025

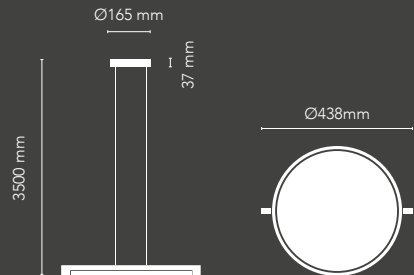

INLAY S3 Ø438 DISC

25W LED - 230V - IP20 - 2700/3000K
CRI: > 90 - Dimmable - Material: Aluminium/ Glass
Lumen 2750lm (nominal)

SWITCH  TUNE™



red dot winner 2023

MATT BLACK/ SATIN GOLD
MATT BLACK/ SATIN SILVER

900028
900027

INLAY

Product Specs

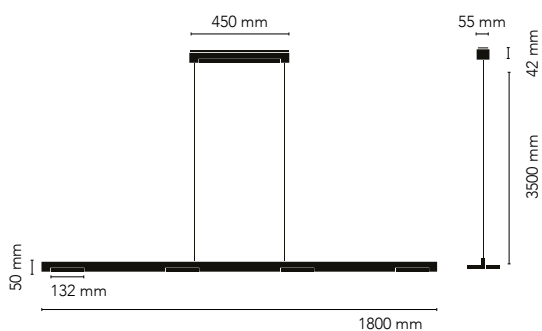
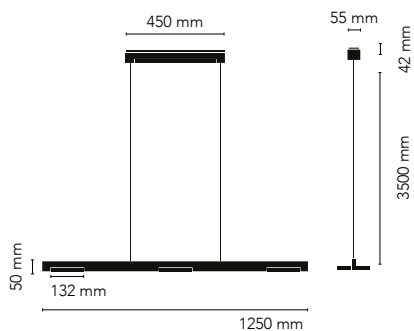

INLAY S1250 LINEAR DISC

3x8W LED - 230V - IP20 - 2700/3000K or 2700-6500K
 CRI: > 90 - Dimmable - Material: Aluminium/ Glass
 Lumen 2640lm (nominal)

SWITCH  TUNE™



reddot winner 2023

MATT BLACK/ SATIN GOLD
 MATT BLACK/ SATIN SILVER

900085
 900084

INLAY S1800 LINEAR DISC

4x9W LED (Switch Tune) or 4x8W LED (Smart Tune) - 230V
 IP20 - 2700/3000K (Switch Tune) or 2700-6500K (Smart Tune)
 CRI: > 90 - Dimmable - Material: Aluminium/ Glass
 Lumen 3520lm (nominal)

SWITCH  TUNE™



reddot winner 2023

MATT BLACK/ SATIN GOLD
 MATT BLACK/ SATIN SILVER

900095
 900094

SMART  TUNE™



reddot winner 2023

MATT BLACK/ SATIN GOLD
 MATT BLACK/ SATIN SILVER

900083
 900082

SMART  TUNE™



reddot winner 2023

MATT BLACK/ SATIN GOLD
 MATT BLACK/ SATIN SILVER

900093
 900092

INLAY LINEAR / Matt Black-Satin Gold



Design by
STUDIO F·A·PORSCHE

INLAY LINEAR / Matt Black-Satin Gold



Design by
STUDIO F-A PORSCHE

INLAY

Product Specs

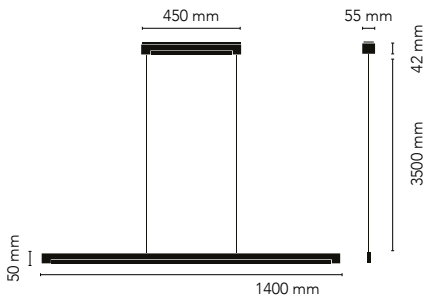

INLAY S1400 LINEAR

30W LED - 230V - IP20 - 2700-6500K
 CRI: > 90 - Dimmable - Material: Aluminium/ Acrylic
 Lumen 3300lm (nominal)



MATT BLACK/ SATIN GOLD	900090
MATT BLACK/ SATIN SILVER	900091

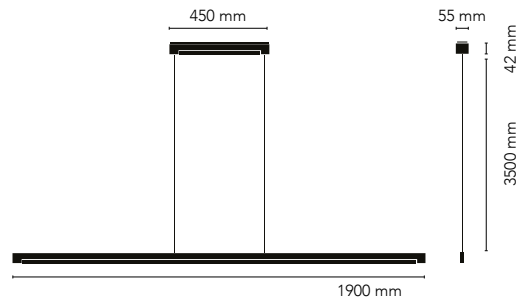

INLAY S1900 LINEAR

38W LED - 230V - IP20 - 2700-6500K
 CRI: > 90 - Dimmable - Material: Aluminium/ Acrylic
 Lumen 4180lm (nominal)



MATT BLACK/ SATIN GOLD	900100
MATT BLACK/ SATIN SILVER	900101

INLAY

Product Specs

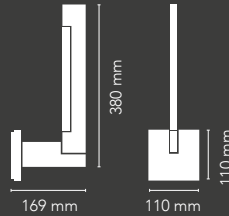
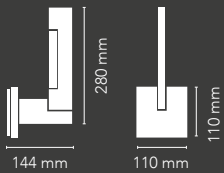

INLAY W1

6W LED - 230V - IP20 - 2700/3000K
 CRI: > 90 - Dimmable - Material: Aluminium/ Acrylic
 Lumen 660lm (nominal)



MATT BLACK/ SATIN GOLD	900030
MATT BLACK/ SATIN SILVER	900031

INLAY W2

9W LED - 230V - IP20 - 2700/3000K
 CRI: > 90 - Dimmable - Material: Aluminium/ Acrylic
 Lumen 990lm (nominal)



MATT BLACK/ SATIN GOLD	900040
MATT BLACK/ SATIN SILVER	900041



INLAY

Product Specs

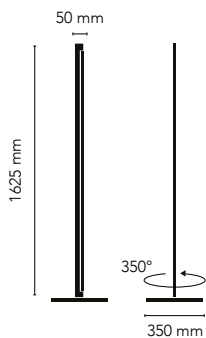

INLAY F1

21W LED - 230V - IP20 - 2700/3000K

CRI: > 90 - Dimmable - Material: Aluminium/ Acrylic

Lumen 2100lm (nominal)

SWITCH  TUNE™



red dot winner 2023

MATT BLACK/ SATIN GOLD	900070
MATT BLACK/ SATIN SILVER	900071
SATIN GOLD/ SATIN GOLD	900072

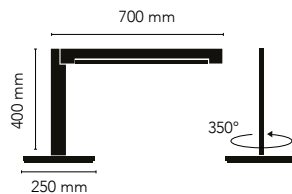

INLAY T2

15W LED - 230V - IP20 - 2700/3000K

CRI: > 90 - Dimmable - Material: Aluminium/ Glass

Lumen 1500lm (nominal)

SWITCH  TUNE™



red dot winner 2023

MATT BLACK/ SATIN GOLD	900050
MATT BLACK/ SATIN SILVER	900051
SATIN GOLD/ SATIN GOLD	900052



LANTERN W2 / Black LANTERN G2 / Black



LANTERN

Product Specs

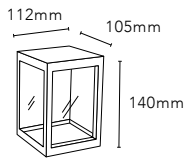

LANTERN W1

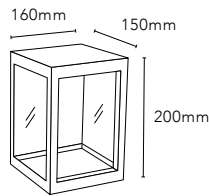

LANTERN W2

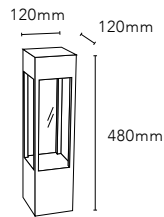

LANTERN G1

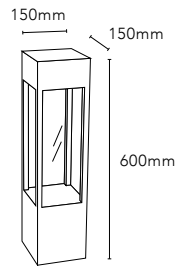

LANTERN G2

Designer

Marie Holsting

Awards



Technical Info

LED | DIMMABLE | IP54 | INDOOR USE | OUTDOOR USE

Colour Options

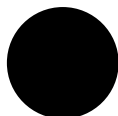

BLACK



LANTERN W1

8W LED | 230V | IP54 | CRI >90 |
Lumen 720lm (nominal)

BLACK 3000K

257513



LANTERN W2

12W LED | 230V | IP54 | CRI >90 |
Lumen 1080lm (nominal)

BLACK 3000K

257517



LANTERN G1

8W LED | 230V | IP54 | CRI >90 |
Lumen 375lm

BLACK 3000K

257526



LANTERN G2

12W LED | 230V | IP20 | CRI >90 |
Lumen 745lm

BLACK 3000K

257530



LANTERN G2 / Black

LINEA Collection

A wall lamp with an edge! LINEA is a new rectangular wall lamp defined by a sharp geometric language. A long and narrow up-down light - thoughtfully designed, inside and out. With its timeless, minimalist expression, LINEA fits seamlessly into LIGHT-POINT's design universe echoing the iconic CUBE lamp with its sculptural, cubist form.

LINEA, however, is lighter and more refined in its details, shaped like a brick. It's the perfect all-round lamp, ideal for both indoor and outdoor use. It works beautifully in a wide range of settings, whether installed alone or in a series. Think hallways, kitchens between upper and lower cabinets, or bathrooms where it provides excellent mirror lighting. It's equally suited to exterior façades, where it becomes an architectural lighting feature.

With LINEA, you can create design continuity - a visual link between indoor and outdoor spaces. The lamp is designed to optimize light output, casting a direct and symmetrical beam upward and downward, with no reflections. Thanks to its matte diffuser, the light remains soft and glare-free.





LINEA W3 / Brass

LINEA W1 / Brass



LINEA

Product Specs

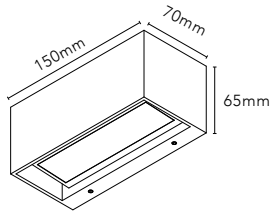

LINEA W1

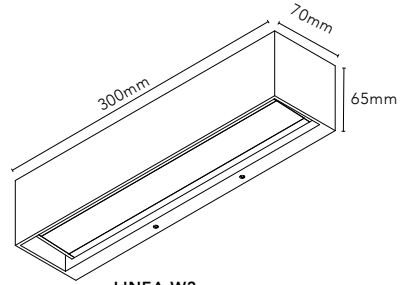

LINEA W2

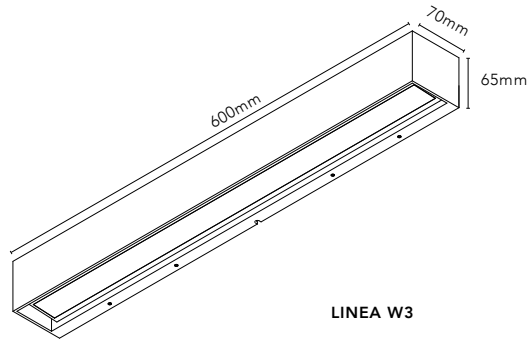

LINEA W3

Designers

NITAL PATEL and RONNI GOL

Technical Info

LED | DIMMABLE | IP54 | INDOOR USE | SWITCH TUNE

SWITCH TUNE gives you the option to choose between 2700K or 3000K before installing the lamp.

Colour Options

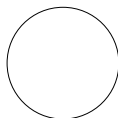

WHITE**

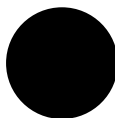

BLACK



BRASS*

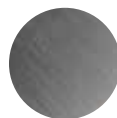

TITANIUM*



ROSE GOLD*

*Anodized surfaces may vary $\pm 10\%$.



LINEA W1

15W LED | 230V | IP54 |
CRI >90 | Lumen 1650lm (nominal)

BRASS 2700/3000K	290102
TITANIUM 2700/3000K	290104
ROSE GOLD 2700/3000K	290103
WHITE 2700/3000K	290100
BLACK 2700/3000K	290101

SWITCH TUNE™



LINEA W2

23W LED | 230V | IP54 |
CRI >90 | Lumen 2530lm (nominal)

BRASS 2700/3000K	290107
TITANIUM 2700/3000K	290109
ROSE GOLD 2700/3000K	290108
WHITE 2700/3000K	290105
BLACK 2700/3000K	290106

SWITCH TUNE™



LINEA W3

30W LED | 230V | IP20 |
CRI >90 | Lumen 3300lm (nominal)

BRASS 2700/3000K	290111
WHITE 2700/3000K	290110

SWITCH TUNE™



LINEA W3 / Titanium



MIRAGE Collection

MIRAGE OUTDOOR STAND resembles a beautiful sculpture, a decoration placed on the ground. While reminiscent of a traditional lantern, it boasts a contemporary and ultra-minimalist look with a concealed LED light source integrated into the top. Like a small pavilion resting on four pillars, it casts light in four directions. This tall and slim outdoor lamp has a refined finish, and, as the name suggests, it carries the same design language as LIGHT-POINT's popular MIRAGE lamp. But is it a circle or a square? It's both - a "squircle." Depending on the angle you look at it from, the shape shifts and transforms its expression.

MIRAGE OUTDOOR STAND can guide you along a driveway or through a garden path, but it's more than just functional lighting. It's a design statement and a visual experience each time you return home or look out at your outdoor space. The lamp creates clarity, contrast, and spatial definition. It shapes atmosphere and visual narratives, making it ideal for transforming outdoor areas.

MIRAGE OUTDOOR STAND is striking on its own, but it truly comes to life when arranged with multiple lamps to form a dynamic lighting landscape, elevating both the lamp and its surroundings to a new level. This version includes Switch Tune technology, allowing you to choose between two light temperatures.







MIRAGE OUTDOOR STAND / Black

MIRAGE W

Product Specs

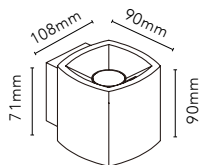

MIRAGE W1

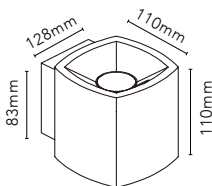

MIRAGE W2

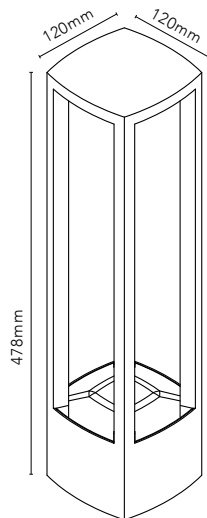

MIRAGE OUTDOOR
STAND

Designer

Nital Patel

Technical Info

LED | DIMMABLE | IP54 | INDOOR USE | OUTDOOR USE | SWITCH TUNE

SWITCH TUNE gives you the option to choose between 2700K or 3000K before installing the lamp.

Two Way Installation

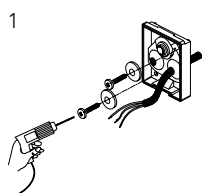

- 1 Direct wall cable installation.
- 2 External wall cable installation.
(Accessory included)

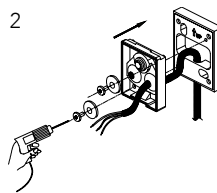

Colour Options



*Anodized surfaces may vary $\pm 10\%$ and are not recommended for outdoor use.



MIRAGE W1 / Rose Gold



MIRAGE W1 / Brass



MIRAGE W1 / White



MIRAGE W1 / Titanium



MIRAGE W1

2x4.5W LED | 230 V | IP54 |
CRI >90 | Lumen 675lm (nominal)

BRASS <small>2700/3000K</small>	271045
TITANIUM <small>2700/3000K</small>	271044
ROSE GOLD <small>2700/3000K</small>	271043
WHITE <small>2700/3000K</small>	271041
BLACK <small>2700/3000K</small>	271040
RUST <small>2700/3000K</small>	271042

SWITCH  TUNE™



MIRAGE W2

2x7W LED | 230 V | IP54 |
CRI >90 | Lumen 1050lm (nominal)

BLACK <small>2700/3000K</small>	271050
RUST <small>2700/3000K</small>	271052

SWITCH  TUNE™



MIRAGE OUTDOOR STAND

16W LED | 230 V | IP54 |
CRI >90 | Lumen 1760m (nominal)

BLACK <small>2700/3000K</small>	271504
RUST <small>2700/3000K</small>	271505

SWITCH  TUNE™



OPTIC OUT

Product Specs

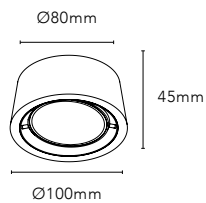

OPTIC OUT 1

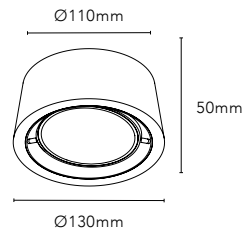

OPTIC OUT 1+

Designer

Ronni Gol

Technical Info

LED | DIMMABLE | IP54 | INDOOR USE | OUTDOOR USE

OPTIC OUT in black and white are including 3 changeable colour rings:
Black, white and gold.

Colour Options

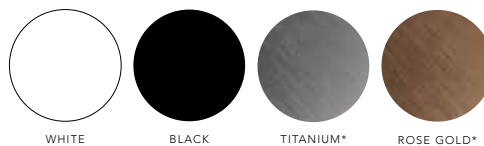

*Anodized surfaces may vary $\pm 10\%$
and are not recommended for
outdoor use.



OPTIC-OUT / Black



OPTIC OUT 1

6W LED | 230V | IP54 | CRI >90 |
Lumen 502lm

ROSE GOLD ^{2700K}	270342
WHITE ^{2700K}	270340
BLACK ^{2700K}	270341



OPTIC OUT 1+

10W LED | 230V | IP54 | CRI >90 |
Lumen 837lm

ROSE GOLD ^{2700K}	270352
WHITE ^{2700K}	270350
BLACK ^{2700K}	270351



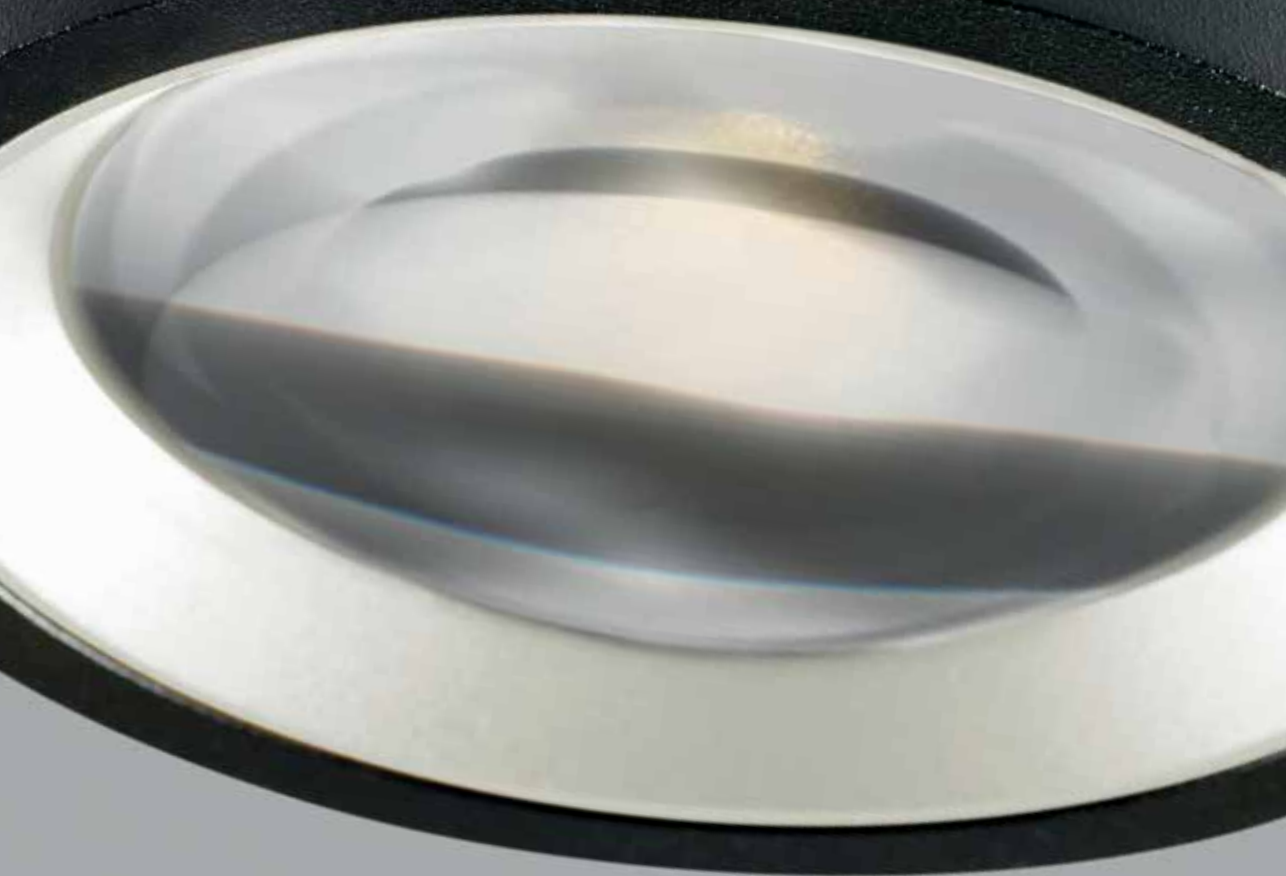



ORBIT W1 / Rose Gold

ORBIT Collection

An elegant and exclusive collection of indoor and outdoor lights, allowing you to create visual continuity and harmony across your indoor and outdoor spaces. ORBIT is the perfect all-around lamp: simple, reliable, and robust, yet light, sculptural, and sophisticated. The lamp casts its light further, wider and softer. The optical glass lens provides glare-free light that won't bother your eyes while still providing the light you need.

For interior use, you can choose from a wall lamp and a floor lamp. ORBIT WALL is an up-down lamp, suitable for corridors or above the kitchen counter. It comes in several sizes. ORBIT FLOOR can be controlled using a touchless sensor, making it easy to switch on and off and adjust the brightness. The floor lamp can also be adjusted in height, and the two spotlights can be controlled individually, so you can customise your lighting experience.



ORBIT FLOOR / Brass

ORBIT WALL MINI / Brass
EDGE LINEAR / Brass
MIRAGE / Brass





ORBIT WALL MINI / Brass



ORBIT STAND / Black





ORBIT WALL W2 / Black

VISUAL CONTINUITY FOR BOTH INDOOR AND OUTDOOR

ORBIT WALL and ORBIT GARDEN are ideal for outdoor spaces, where they create both exciting and calm light, whether on facades or standing on the ground. With its up-down light, ORBIT WALL provides beautiful shadows on walls along the entrance or on the terrace. Available in black and white.

ORBIT GARDEN is a floor lamp that can accompany you from your driveway to your door, as well as in the garden, where it works well in flower beds. This model is only available in black.

ORBIT FLOOR

Product Specs

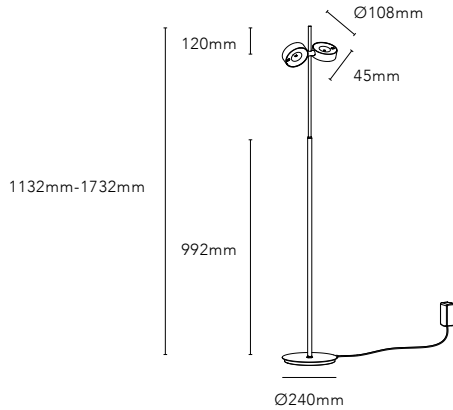

ORBIT FLOOR

Designer

Ronni Gol & Nital Patel

Award



Technical Info

LED | DIMMABLE | IP20 | INDOOR USE | TOUCHLESS SENSOR

ORBIT FLOOR is height adjustable and both spots can be positioned and rotated independently from one another. It is dimmable with an integrated touchless sensor.

Colour Options

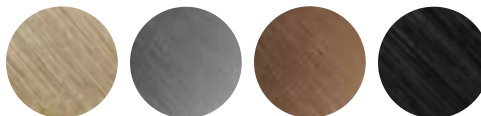

*Anodized surfaces may vary ±10%

BRASS*

TITANIUM*

ROSE GOLD*

CARBON BLACK*



ORBIT WALL

Product Specs

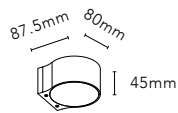

ORBIT WALL MINI

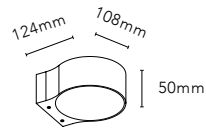

ORBIT WALL W1

Designer

Ronni Gol & Nital Patel

Award



Technical Info

LED | DIMMABLE | IP54 | INDOOR USE | OUTDOOR USE

Colour Options

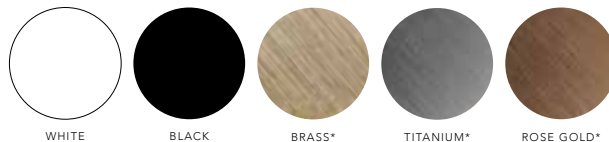

*Anodized surfaces may vary $\pm 10\%$ and are not recommended for outdoor use.

WHITE

BLACK

BRASS*

TITANIUM*

ROSE GOLD*



ORBIT WALL W1 / Brass



ORBIT GARDEN

Product Specs

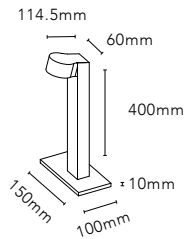

ORBIT GARDEN MINI

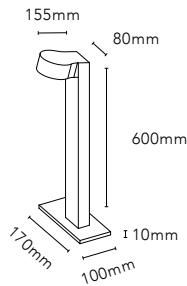

ORBIT GARDEN 1

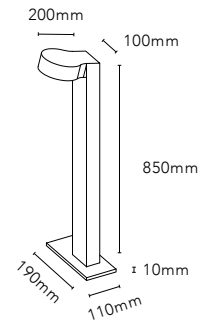

ORBIT GARDEN 2

Designer

Ronni Gol & Nital Patel

Award



Technical Info

LED | DIMMABLE | IP54 | INDOOR USE | OUTDOOR USE

Colour Options



BLACK



ORBIT FLOOR

2x6W LED | 230V | IP20 | CRI >90 |
Lumen 2250lm

BRASS 2700K	270783
TITANIUM 2700K	270781
ROSE GOLD 2700K	270780
CARBON BLACK 2700K	270782



ORBIT WALL MINI

2x4W LED | 230V | IP54 | CRI >90 |
Lumen (nominal) 720lm (3000K) / 720lm
(2700K)

BRASS 2700K	270574
TITANIUM 2700K	270573
ROSE GOLD 2700K	270572
WHITE 2700K	270570
BLACK 2700K	270571
BLACK 3000K	268311



ORBIT WALL W1

2x8W LED | 230V | IP54 | CRI >90 |
Lumen (nominal) 1440lm (3000K) / 1440lm
(2700K)

BRASS 2700K	270584
TITANIUM 2700K	270583
ROSE GOLD 2700K	270582
WHITE 2700K	270580
BLACK 2700K	270581
BLACK 3000K	268321



ORBIT GARDEN MINI

6W LED | 230V | IP54 | CRI >90 |
Lumen 540lm (nominal)

BLACK 3000K

268300



ORBIT GARDEN 1

10W LED | 230V | IP54 | CRI >90 |
Lumen 900lm (nominal)

BLACK 3000K

268301



ORBIT GARDEN 2

15W LED | 230V | IP54 | CRI >90 |
Lumen 1350lm (nominal)

BLACK 3000K

268302



RAW

Product Specs

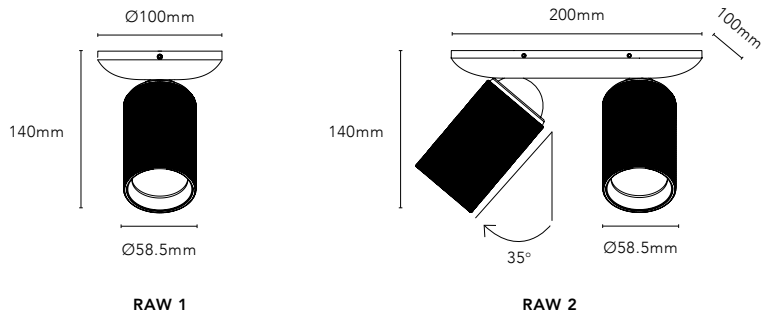

Designer

Nital Patel

Technical Info

LED | DIMMABLE | IP20 | INDOOR USE | SWITCH TUNE*

*SWITCH TUNE is only available for RAW 1 and RAW 2 in Brass and Rose Gold.

SWITCH TUNE gives you the option to choose between 2700K or 3000K before installing the lamp.*

Colour Options

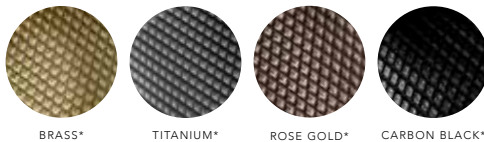

*Anodized surfaces may vary $\pm 10\%$





RAW 1

6W LED | 230V | IP20 | CRI >90 |
Lumen 510lm

TITANIUM 3000K	270952
CARBON BLACK 3000K	270950
BRASS 2700/3000K	271253
ROSE GOLD 2700/3000K	271251

SWITCH  **TUNE**™



RAW 2

2x6W LED | 230V | IP20 | CRI >90 |
Lumen 1050lm

TITANIUM 3000K	270958
CARBON BLACK 3000K	270956
BRASS 2700/3000K	271259
ROSE GOLD 2700/3000K	271257

SWITCH  **TUNE**™





RØRHAT STAND / Black

RØRHAT Collection

RØRHAT is a true Danish design icon! It has a semicircular shape – a timeless classic. Designed by Jesper Juhl Pedersen in 1989, this lamp is still produced in Denmark from the finest materials. The originality, simple lines, high quality, and affordable price point of the RØRHAT make it a popular lamp. Beautiful on a carport or garage, or on a wall, like for instance next to the front door. It is also available as a bollard, with light in one or two directions.

The RØRHAT range includes a selection of mounting hardware and nameplates, so you can personalise your RØRHAT lamp. The lamp can even withstand harsh wind and weather, but it is also suitable for indoor use. The lamp is available in a variety of finishes: classic black or white, polished chrome, galvanised, rust, and stainless steel. It is also available in raw or polished copper and polished brass for indoor use only. A super functional lamp: 100% Danish design and 100% value for money.



RØRHAT NAMEPLATE KIT / Galvanized



RØRHAT WALL

Product Specs

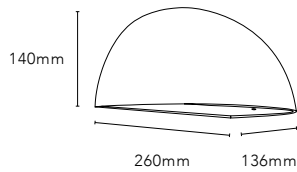

RØRHAT WALL E14

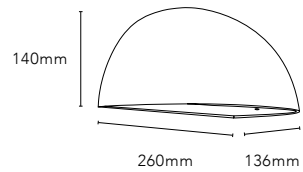

RØRHAT WALL LED

Designer

Jesper J. Pedersen

Technical Info

LED | DIMMABLE | IP23 | INDOOR USE | OUTDOOR USE

Colour Options



*Anodized surfaces are not recommended for outdoor use.

RØRHAT WALL LED / RØRHAT WALL MOUNT / RØRHAT NAMEPLATE / RØRHAT NAMEPLATE XL / Raw Copper



RØRHAT WALL ACCESSORIES

Product Specs

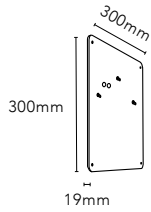

RØRHAT WALL MOUNT

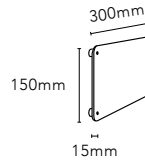

RØRHAT NAMEPLATE



RØRHAT NAMEPLATE XL

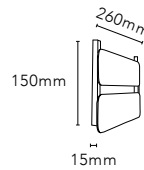

RØRHAT NAMEPLATE KIT

Designer

Jesper J. Pedersen

Colour Options

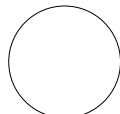

WHITE



BLACK



RUST



RAW COPPER



COPPER*



STAINL. STEEL



GALVANIZED



BRASS*

*Anodized surfaces are not recommended for outdoor use.

RØRHAT STAND

Product Specs

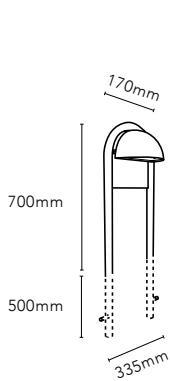

RØRHAT STAND

Maximum height over ground:
700mm

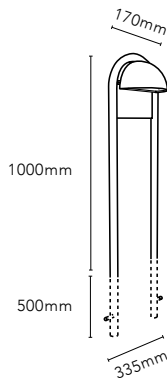

RØRHAT STAND XL

Maximum height over ground:
1000mm

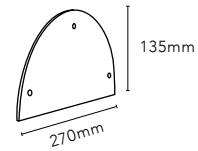

RØRHAT COVER PLATE

Designer

Jesper J. Pedersen

Technical Info

IP23 | INDOOR USE | OUTDOOR USE

Colour Options

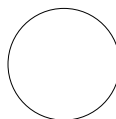

WHITE



BLACK



RAW COPPER



GALVANIZED





RØRHAT WALL E14

40W | E14 | 230V | IP23

WHITE	256710
BLACK	256711
RUST	256719
COPPER RAW	256713
COPPER	256714
BRASS	256715
STAINLESS STEEL	256717
GALVANIZED	256712



RØRHAT WALL LED

10.5W LED | 230V | IP23 | CRI >80
Lumen | 333lm

WHITE	256720
BLACK	256721
RUST	256830
COPPER RAW	256723
COPPER	256724
BRASS	256725
STAINLESS STEEL	256727
GALVANIZED	256722



RØRHAT WALL MOUNT

30 x 30 cm - to be completed with lamp.
Lamp is not included.

WHITE	256731
BLACK	256730
GALVANIZED	256732
COPPER RAW	256733
STAINLESS STEEL	256737



WHITE



RAW COPPER



COPPER



RØRHAT NAMEPLATE

15 x 30 cm

WHITE	256750
BLACK	256751
GALVANIZED	256752
COPPER RAW	256753
STAINLESS STEEL	256757



RØRHAT NAMEPLATE XL

30 x 30 cm

WHITE	256740
BLACK	256741
GALVANIZED	256742
COPPER RAW	256743
STAINLESS STEEL	256747



RØRHAT NAMEPLATE KIT

25 x 16.5 cm - two plates fixed on tracks.
Lamp is not included.

WHITE	256760
BLACK	256761
GALVANIZED	256762
BRASS	256765
COPPER	256764
COPPER RAW	256763
STAINLESS STEEL	256767



BRASS



GALVANIZED



RUST



RØRHAT STAND

Post only. To complete lamp post, order lamp and cover plate.

WHITE	256770
BLACK	256771
GALVANIZED	256772
COPPER RAW	256773



RØRHAT STAND XL

Post only. To complete lamp post, order lamp and cover plate.

WHITE	256780
BLACK	256781
GALVANIZED	256782
COPPER RAW	256783



RØRHAT COVER PLATE

Cover plate for use when fixing only one lamp.

WHITE	256790
BLACK	256791
GALVANIZED	256792
COPPER RAW	256793

RØRHAT MOUNTING KIT

For use when fixing two lamps on one post.

WHITE	256799
-------	--------



RØRHAT STAND / Black

SERIOUS

Product Specs

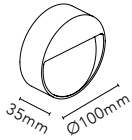

SERIOUS 1

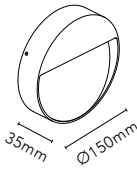

SERIOUS 2

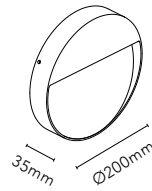

SERIOUS 3

Designer

Ronni Gol

Technical Info

LED | DIMMABLE | IP54 | INDOOR USE | OUTDOOR USE

Colour Options

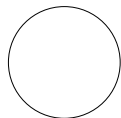

WHITE



BLACK



BRASS*

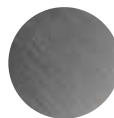

TITANIUM*



ROSE GOLD*

*Anodized surfaces may vary $\pm 10\%$ and are not recommended for outdoor use.







SERIOUS 1

4W LED | 230V | IP54 | CRI >90
Lumen 440lm (nominal)

BRASS ^{2700K}	270754
TITANIUM ^{2700K}	270753
ROSE GOLD ^{2700K}	270752
WHITE ^{2700K}	270750
BLACK ^{2700K}	270751



SERIOUS 2

6.5W LED | 230V | IP54 | CRI >90
Lumen 715lm (nominal)

BRASS ^{2700K}	270764
TITANIUM ^{2700K}	270763
ROSE GOLD ^{2700K}	270762
WHITE ^{2700K}	270760
BLACK ^{2700K}	270761



SERIOUS 3

12W LED | 230V | IP54 | CRI >90
Lumen 1320lm (nominal)

TITANIUM ^{2700K}	270773
ROSE GOLD ^{2700K}	270772
WHITE ^{2700K}	270770
BLACK ^{2700K}	270771

SHADOW

Product Specs

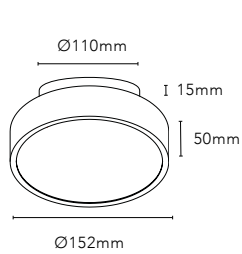

SHADOW 1

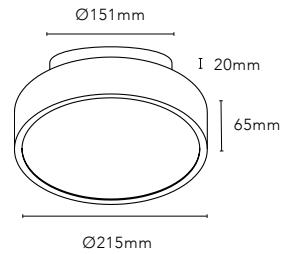

SHADOW 2

Designer

Ronni Gol

Technical Info

LED | DIMMABLE | IP54 | INDOOR USE | OUTDOOR USE | SWITCH TUNE

SWITCH TUNE gives you the option to choose between 2700K or 3000K before installing the lamp.

Colour Options

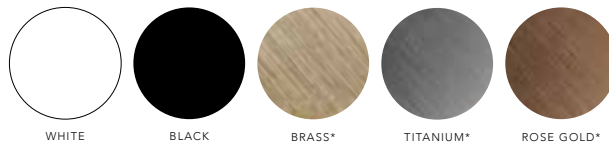

*Anodized surfaces may vary $\pm 10\%$ and are not recommended for outdoor use.







SHADOW 1

7W+3W LED | 230V | IP54 | CRI >90 |
Lumen 1100lm (nominal)

BRASS 2700/3000K	270607
TITANIUM 2700/3000K	270606
ROSE GOLD 2700/3000K	270605
WHITE 2700/3000K	270603
BLACK 2700/3000K	270604

SWITCH  TUNE™



SHADOW 2

13W+4W LED | 230V | IP54 | CRI >90 |
Lumen 1950lm (nominal)

BRASS 2700/3000K	290618
TITANIUM 2700/3000K	290617
ROSE GOLD 2700/3000K	290616
WHITE 2700/3000K	290615
BLACK 2700/3000K	290614

SWITCH  TUNE™

SKY

Product Specs

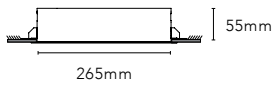

SKY 265

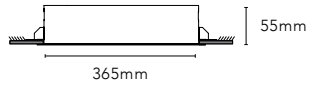

SKY 365

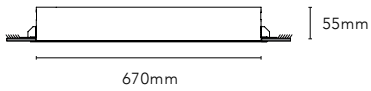

SKY 670

Designer

LP Design Team

Technical Info

LED | DIMMABLE | IP20 | INDOOR USE

Colour Options

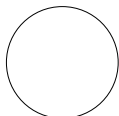

WHITE





SKY 265

18W LED | 230V | IP20 | CRI >90 |
Lumen 1185lm

WHITE 3000K 257720



SKY 365

24W LED | 230V | IP20 | CRI >90 |
Lumen 1645lm

WHITE 3000K 257723



SKY 670

40W LED | 230V | IP20 | CRI >90 |
Lumen 3090lm

WHITE 3000K 257729



SLIM Collection



SLIM S1500 / Titanium





SLIM S1800 / Rose Gold

SUBTLE SOPHISTICATION

Like a line in the air. A study in style. SLIM is an elegant and efficient light source that's ideal to place above dining or meeting tables. Hanging like a trapeze on two thin fabric cables and equipped with a discreet bracket, it effectively casts a soft, warm, and diffuse light over its surroundings.

The SLIM pendant doesn't obstruct your view or get in the way, even from above. It hangs like a design statement and blends into any environment. Available in three lengths.

SLIM

Product Specs

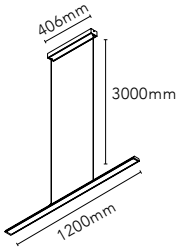

SLIM S1200

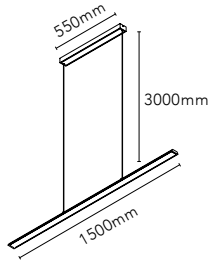

SLIM S1500

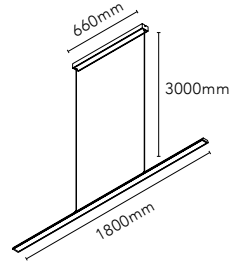

SLIM S1800

General Measurements

All three sizes

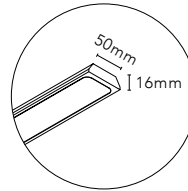
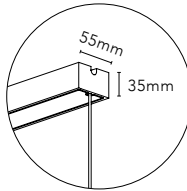

Designer

Ronni Gol

Technical Info

LED | DIMMABLE | IP20 | INDOOR USE

Pendant height up to 3000 mm.

Colour Options

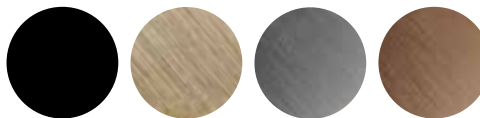

*Anodized surfaces may vary $\pm 10\%$

BLACK

BRASS*

TITANIUM*

ROSE GOLD*



SLIM S1200 / Brass



SLIM S1200

30W LED | 230V | IP20 | CRI >90 | Lumen
1830lm (nominal)

BRASS 2700/3000K	280804
TITANIUM 2700/3000K	280803
ROSE GOLD 2700/3000K	280702
BLACK 2700/3000K	280801

SWITCH  TUNE™



SLIM S1500

34W LED | 230V | IP20 | CRI >90 |
Lumen 2140lm (nominal)

BRASS 2700/3000K	280714
TITANIUM 2700/3000K	280713
ROSE GOLD 2700/3000K	280712
BLACK 2700/3000K	280811

SWITCH  TUNE™



SLIM S1800

36W LED | 230V | IP20 | CRI >90 |
Lumen 2450lm (nominal)

BRASS 2700/3000K	280824
TITANIUM 2700/3000K	280723
ROSE GOLD 2700/3000K	280722
BLACK 2700/3000K	280821

SWITCH  TUNE™

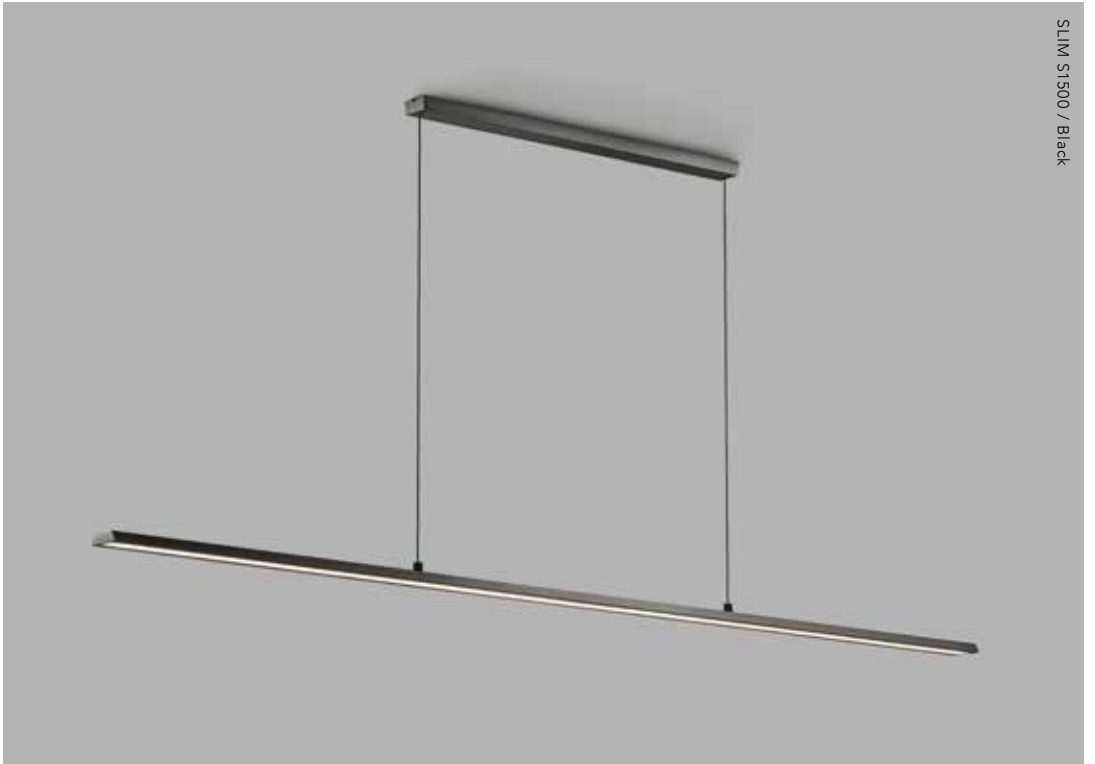



SOHO Collection

Like luminous art on the wall! SOHO is a wall-mounted system of circles/discs that you can freely place on the wall in all kinds of creative formations. You can mix and match colours and sizes to create a personal and artistic expression in your indoor and outdoor spaces. SOHO is ideal as a mood-setter and eye-catcher in the home, as well as in offices, hotels, restaurants, lobbies, showrooms, and shops. SOHO can also be used outdoors. Available in five sizes, all with varying depths to create overlapping patterns on a wall.

Winner of the Red Dot Design Award.







SOHO / Black

SOHO

Product Specs

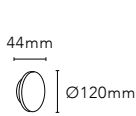

SOHO W1

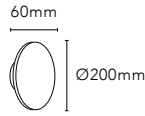

SOHO W2

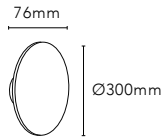

SOHO W3

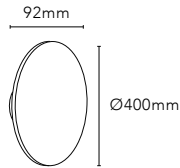

SOHO W4

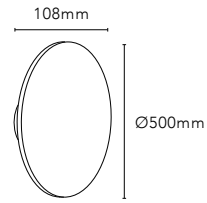

SOHO W5

Designer

Ronni Gol

Award



reddot winner 2020

Technical Info

LED | DIMMABLE | IP54 | INDOOR USE | OUTDOOR USE | SWITCH TUNE

SWITCH TUNE gives you the option to choose between 2700K or 3000K before installing the lamp.

Colour Options

*Anodized surfaces may vary $\pm 10\%$ and are not recommended for outdoor use.

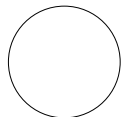

WHITE



BLACK



BRASS*

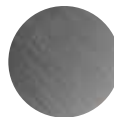

TITANIUM*



ROSE GOLD*



GOLD*



SOHO W1 / SOHO W2 / Brass
CURVE / Brass

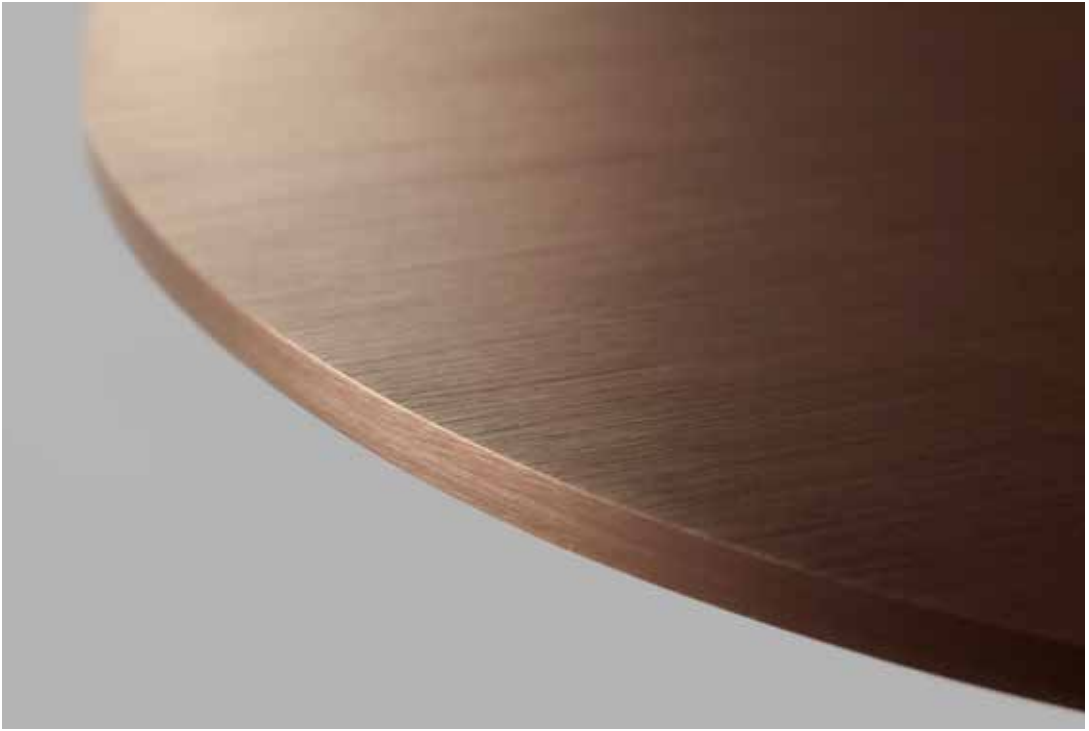

SOHO W1

6W LED | 230V | IP54 | CRI >90
Lumen 469lm (nominal)

BRASS 2700/3000K	270148
TITANIUM 2700/3000K	270147
ROSE GOLD 2700/3000K	270146
WHITE 2700/3000K	270143
BLACK 2700/3000K	270144
GOLD 2700/3000K	270145

SWITCH  TUNE™



SOHO W2

8W LED | 230V | IP54 | CRI >90
Lumen 625lm (nominal)

BRASS 2700/3000K	270158
TITANIUM 2700/3000K	270157
ROSE GOLD 2700/3000K	270156
WHITE 2700/3000K	270153
BLACK 2700/3000K	270154
GOLD 2700/3000K	270155

SWITCH  TUNE™



SOHO W3

11W LED | 230V | IP54 | CRI >90
Lumen 860lm (nominal)

BRASS 2700/3000K	270168
TITANIUM 2700/3000K	270167
ROSE GOLD 2700/3000K	270166
WHITE 2700/3000K	270163
BLACK 2700/3000K	270164
GOLD 2700/3000K	270165

SWITCH  TUNE™



SOHO W4

15W LED | 230V | IP54 | CRI >90
Lumen 1173lm (nominal)

BRASS 2700/3000K	270178
TITANIUM 2700/3000K	270177
ROSE GOLD 2700/3000K	270176
WHITE 2700/3000K	270173
BLACK 2700/3000K	270174
GOLD 2700/3000K	270175

SWITCH  TUNE™



SOHO W5

18W LED | 230V | IP54 | CRI >90
Lumen 1407lm (nominal)

BRASS 2700/3000K	270188
TITANIUM 2700/3000K	270187
ROSE GOLD 2700/3000K	270186
WHITE 2700/3000K	270184
BLACK 2700/3000K	270183
GOLD 2700/3000K	270185

SWITCH  TUNE™

SOLO

Product Specs

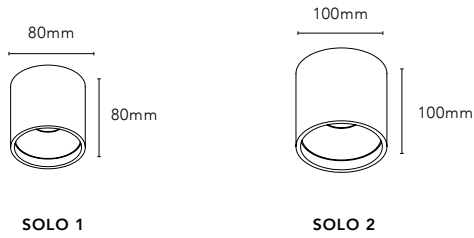

Designer

Ronni Gol

Technical Info

LED | DIMMABLE | IP54 | INDOOR USE | OUTDOOR USE

Colour Options

*Anodized surfaces may vary $\pm 10\%$.
Anodized surfaces and Black/Gold are not recommended for outdoor use.

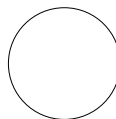

WHITE

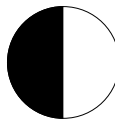

BLACK/WHITE



BLACK/GOLD*

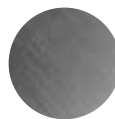

TITANIUM*



ROSE GOLD*



BRASS*



SOLO 1 / Titanium
AURA W3 / Titanium



SOLO 1

6W LED | 230V | IP54 | CRI >90 |
Lumen 415lm (3000K) / 386lm (2700K)

BRASS 2700K	270214
TITANIUM 2700K	270213
ROSE GOLD 2700K	270212
WHITE 2700K	270210
BLACK/WHITE 2700K	270211
WHITE 3000K	258990
BLACK/WHITE 3000K	258991
BLACK/GOLD 3000K	258992



SOLO 2

10W LED | 230V | IP54 | CRI >90 |
Lumen 900lm (3000K) / 837lm (2700K)

BRASS 2700K	270194
TITANIUM 2700K	270193
ROSE GOLD 2700K	270192
WHITE 2700K	270190
BLACK/WHITE 2700K	270191
WHITE 3000K	259020
BLACK/WHITE 3000K	259021







SPIRIT Collection

SPIRIT is an ultra-modern lamp for anyone who's looking for something special. It has a raw, urban, and industrial look. SPIRIT has a distinctive, three-dimensional look with one or more tube-shaped light sources that are attached to the pole with a magnet, so they can be moved freely as needed. This makes SPIRIT a super functional and flexible lamp. Available as a pendant, floor, and table lamp. The latter two models are equipped with an innovative on/off switch with a built-in dimmer function, allowing you to easily and elegantly adjust the brightness by simply holding your finger on the button.

SPIRIT S2000 / Titanium/Black



SPIRIT T1 / Rose Gold/Black

SPIRIT F1 / SPIRIT T2

Product Specs

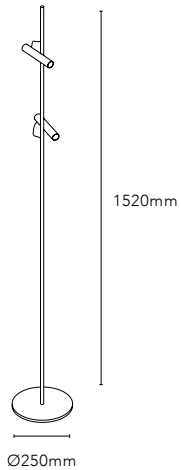

SPIRIT F1

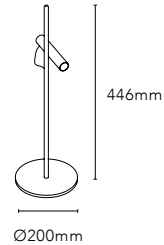

SPIRIT T1

Designer

Ronni Gol

Technical Info

LED | DIMMABLE | IP20 | INDOOR USE | | TOUCH DIMMING

Colour Options



*Anodized surfaces may vary $\pm 10\%$

TITANIUM/
BLACK*

ROSE GOLD/
BLACK*

BRASS/
BLACK*



SPRIT S

Product Specs

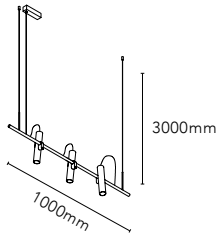

SPIRIT S1000

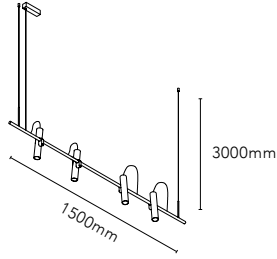

SPIRIT S1500

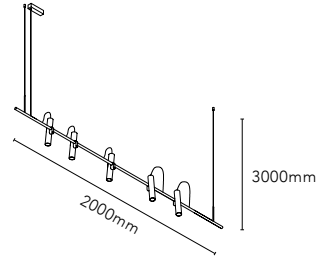

SPIRIT S2000

General Measurements
All three sizes

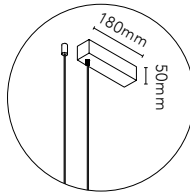

Designer

Ronni Gol

Technical Info

LED | DIMMABLE | IP20 | INDOOR USE |

Pendant height up to 3000 mm.

Colour Options



*Anodized surfaces may vary $\pm 10\%$

TITANIUM/
BLACK*

ROSE GOLD/
BLACK*

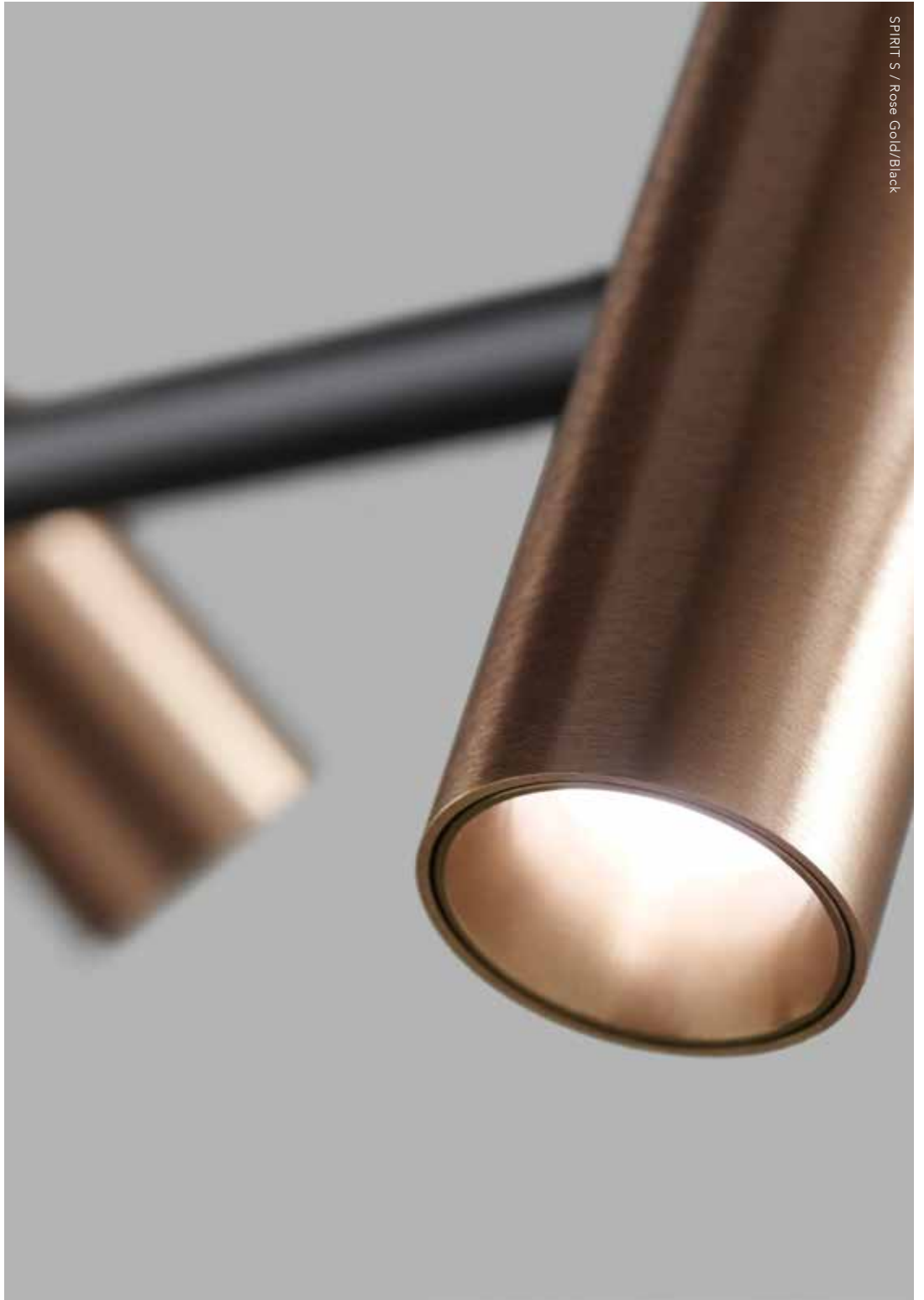



SPIRIT F1

2x5W LED | 230V | IP20 | CRI >90 |
Lumen 1110lm

BRASS/BLACK 2700K	270645
TITANIUM/BLACK 2700K	270644
ROSE GOLD/BLACK 2700K	270643



SPIRIT T1

5W LED | 230V | IP20 | CRI >90 |
Lumen 550lm

BRASS/BLACK 2700K	270655
TITANIUM/BLACK 2700K	270654
ROSE GOLD/BLACK 2700K	270653





SPIRIT S1000

3x5W LED | 230V | IP20 | CRI >90 |
Lumen 1650lm

TITANIUM/BLACK ^{2700K}	270614
ROSE GOLD/BLACK ^{2700K}	270610



SPIRIT S1500

4x5W LED | 230V | IP20 | CRI >90 |
Lumen 2200lm

TITANIUM/BLACK ^{2700K}	270624
ROSE GOLD/BLACK ^{2700K}	270620



SPIRIT S2000

5x5W LED | 230V | IP20 | CRI >90 |
Lumen 2750lm

TITANIUM/BLACK ^{2700K}	270634
ROSE GOLD/BLACK ^{2700K}	270630

STRIPE

Collection



STRIPE S1500 / Titanium





STRIPE S2000 / Brass

CONTEMPORARY MINIMALISM

An emblem of modern style! Play with the effects of light with STRIPE: A collection of two pendant lights and two wall lights with a strict, architectural, and sophisticated expression. It's a very contemporary lighting object that lets you create exciting scenes and imaginative landscapes of light in your home. STRIPE is the epitome of minimalist design. Everything superfluous has been cut out, making it graphic and sculptural above a kitchen table, dining table, or desk, on a wall, or on the ceiling. STRIPE is a gallery piece – it's a work of art, so simple, and yet capable of transforming your entire interior.





STRIPE S

Product Specs

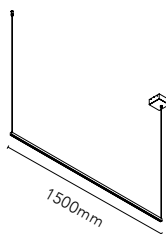

STRIPE S1500

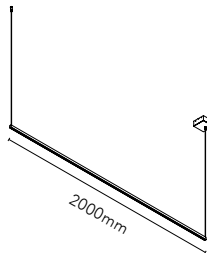

STRIPE S2000

General Measurements
Both sizes

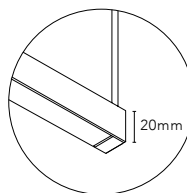
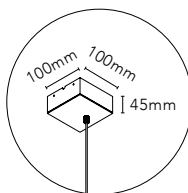

Designer

Ronni Gol

Technical Info

LED | DIMMABLE | IP20 | INDOOR USE | SWITCH TUNE

SWITCH TUNE gives you the option to choose between 2700K or 3000K before installing the lamp.

Pendant height up to 4500 mm.

Alternative Mounting
Option

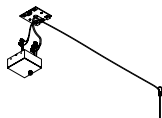

Colour Options

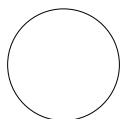

WHITE



BLACK



BRASS*



TITANIUM*



ROSE GOLD*

*Anodized surfaces may vary $\pm 10\%$



STRIPE S1500 / Rose Gold



STRIPE C/W 2000 / Black

STRIPE C/W

Product Specs

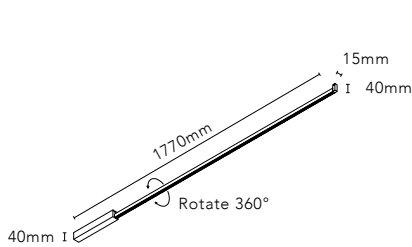

STRIPE C/W 1500

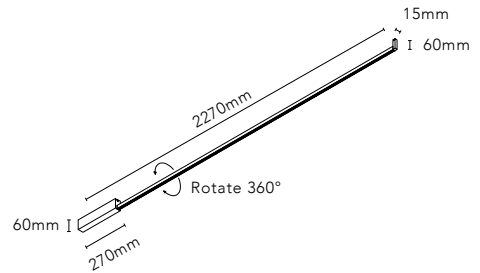

STRIPE C/W 2000

Designer

Ronni Gol

Technical Info

LED | DIMMABLE | IP20 | INDOOR USE

The light source can be rotated 360°.

Colour Options

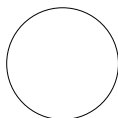

WHITE

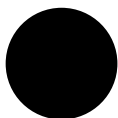

BLACK



BRASS*



STRIPE S1500

30W LED | 230V | IP20 | CRI >90 |
Lumen 2430lm (nominal)

BRASS 2700/3000K	270364
TITANIUM 2700/3000K	270363
ROSE GOLD 2700/3000K	270362
WHITE 2700/3000K	270365
BLACK 2700/3000K	270366

SWITCH  TUNE™



STRIPE S2000

36W LED | 230V | IP20 | CRI >90 |
Lumen 2970lm (nominal)

BRASS 2700/3000K	270374
TITANIUM 2700/3000K	270373
ROSE GOLD 2700/3000K	270372
WHITE 2700/3000K	270375
BLACK 2700/3000K	270376

SWITCH  TUNE™



STRIPE C/W 1500

25W LED | 230V | IP20 | CRI >90 | Lumen
2700lm

WHITE 2700K	270660
BLACK 2700K	270661
BRASS 2700K	NEW 271506

SWITCH  TUNE™



STRIPE C/W 2000

30W LED | 230V | IP20 | CRI >90 | Lumen
2970lm

WHITE 2700K	270670
BLACK 2700K	270671
BRASS 2700K	NEW 271507

SWITCH  TUNE™





SURFACE

Product Specs

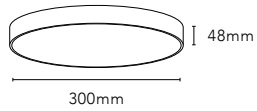

SURFACE 300

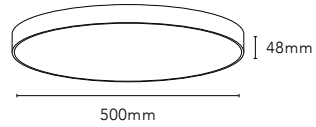

SURFACE 500

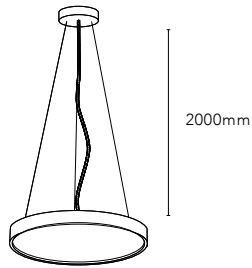

SUSPENSION KIT 2M

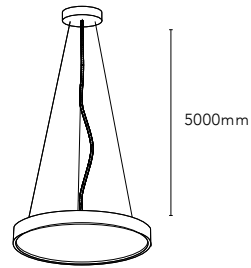

SUSPENSION KIT 5M

Designer

LP Design Team

Technical Info

LED | DIMMABLE | IP54 | INDOOR USE | OUTDOOR USE

Colour Options

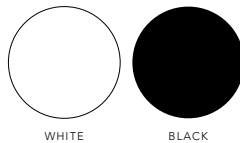





SURFACE 300

20W LED | 230V | IP54 | CRI >90 |
Lumen 1185lm

WHITE ^{3000K}	257700
BLACK ^{3000K}	257701



SURFACE 500

32W LED | 230V | IP54 | CRI >90 |
Lumen 2660lm

WHITE ^{3000K}	257705
BLACK ^{3000K}	257706



SUSPENSION KIT 2M

Prices are only for the suspension part.

WHITE	257715
BLACK	257716



SUSPENSION KIT 5M

Prices are only for the suspension part.

WHITE	257717
BLACK	257718





VANTAGE

Collection



VANTAGE / Rose Gold

MAXIMUM LIGHT VERSATILITY

VANTAGE is a state-of-the-art award-winning LED spot lamp that works optically, spreading light further, wider and softer. Replacing traditional reflectors with an optic glass provides glare free light, eliminating annoyance to the eyes. The collection is made up of four sizes and five colours; in a structured powder coated black and white and in a brushed rose gold, titanium and our new colour brass. Each lamp is made from CNC machined high quality aluminium which is the best choice of material for absorbing heat created by the LED.

VANTAGE

Product Specs

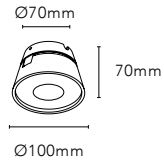

VANTAGE 1

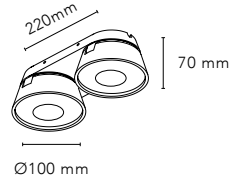

VANTAGE 2

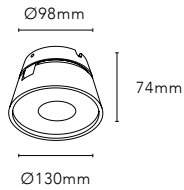

VANTAGE 1+

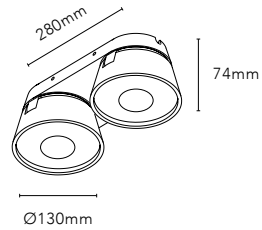

VANTAGE 2+

Designer

Nital Patel

Award



Technical Info

LED | DIMMABLE | IP20 | INDOOR USE

The spot can be pivoted at 90 degrees to the mounting point and rotated almost 360 degrees.

Colour Options



*Anodized surfaces may vary ±10%

WHITE

BLACK

BRASS*

TITANIUM*

ROSE GOLD*





VANTAGE 1

8W LED | 230V | IP20 | CRI >90 |
Lumen 720lm (nominal)

BRASS ^{2700K}	270697
TITANIUM ^{2700K}	270696
ROSE GOLD ^{2700K}	270695
WHITE ^{2700K}	270693
BLACK ^{2700K}	270694



VANTAGE 1+

15W LED | 230V | IP20 | CRI >90 |
Lumen 1350lm (nominal)

BRASS ^{2700K}	270707
TITANIUM ^{2700K}	270706
ROSE GOLD ^{2700K}	270705
WHITE ^{2700K}	270703
BLACK ^{2700K}	270704



VANTAGE 2

16W LED | 230V | IP20 | CRI >90 |
Lumen 1440lm (nominal)

BRASS ^{2700K}	270824
TITANIUM ^{2700K}	270823
ROSE GOLD ^{2700K}	270822
WHITE ^{2700K}	270820
BLACK ^{2700K}	270821



VANTAGE 2+

30W LED | 230V | IP20 | CRI >90 |
Lumen 2700lm (nominal)

BRASS ^{2700K}	270834
TITANIUM ^{2700K}	270833
ROSE GOLD ^{2700K}	270832
WHITE ^{2700K}	270830
BLACK ^{2700K}	270831





ZERO Collection

No-nonsense design. ZERO is a family of elegant, cylindrical pendant and wall lights. These lamps are streamlined and minimalistic, spreading a soft, comfortable, and glare-free light. The pendant can hang alone or in a group of several. The wall lights illuminate both upwards and downwards and can be used in all rooms, including bathrooms and outdoor spaces (in black and white).

ZERO W / Rose Gold



ZERO S1 / Brass





ZERO S

Product Specs

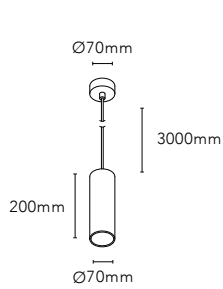

ZERO S1

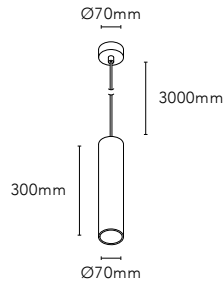

ZERO S2

Designer

Ronni Gol

Technical Info

GU10 | DIMMABLE* | INDOOR USE |

*Dimming is dependent on light source.

See additional ceiling bases on page 196.

Colour Options

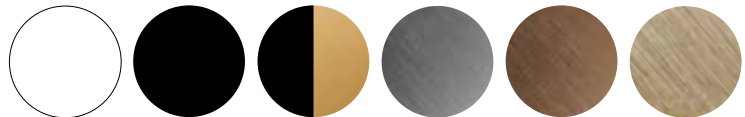

*Anodized surfaces may vary $\pm 10\%$

WHITE

BLACK

BLACK/GOLD*

TITANIUM*

ROSE GOLD*

BRASS*



ZERO S1 / Brass



ZERO W2 / Rose Gold

ZERO W

Product Specs

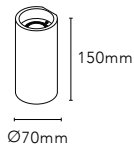

ZERO W1

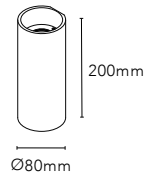

ZERO W2

Designer

Ronni Gol

Technical Info

LED | DIMMABLE | IP54 | INDOOR USE | OUTDOOR USE

Colour Options

*Anodized surfaces may vary $\pm 10\%$ and are not recommended for outdoor use.

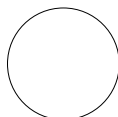

WHITE



BLACK



TITANIUM*



ROSE GOLD*



ZERO S1

GU10 | 50W max | 230V | IP20 |

BRASS	280117
TITANIUM	280116
ROSE GOLD	280115
WHITE	280110
BLACK	280111
BLACK/GOLD	280113



ZERO S2

GU10 | 50W max | 230V | IP20 |

BRASS	280127
TITANIUM	280126
ROSE GOLD	280125
WHITE	280120
BLACK	280121
BLACK/GOLD	280123



ZERO W1

2x4W LED | 230V | IP54 | CRI >90 |
Lumen 530lm (3000K) / 720lm (2700K)

TITANIUM ^{2700K}	270713
ROSE GOLD ^{2700K}	270712
WHITE ^{3000K}	256320
BLACK ^{3000K}	256321



ZERO W2

2x6W LED | 230V | IP54 | CRI >90 |
Lumen 960lm (3000K) / 720lm (2700K)

TITANIUM ^{2700K}	270725
ROSE GOLD ^{2700K}	270724
WHITE ^{3000K}	256317
BLACK ^{3000K}	256318



ZERO S2 / Brass

ZERO CEILING BASES

Product Specs

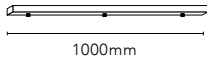

CEILING BASE L1000
3 Pendants

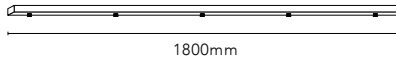

CEILING BASE L1800
5 Pendants

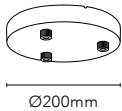

CEILING BASE Ø200
3 Pendants

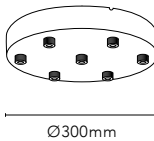

CEILING BASE Ø300
7 Pendants

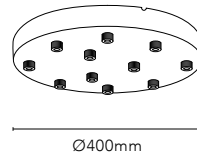

CEILING BASE Ø400
11 Pendants

Designer

LP Design Team

Technical Info

To be combined with the DROP pendant (see page ??) or the ZERO pendant (see page ???).

Colour Options

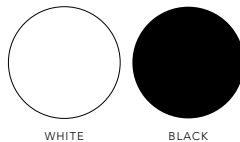



**CEILING BASE L1000
3 PENDANTS**

WHITE	280540
-------	--------



**CEILING BASE L1800
5 PENDANTS**

WHITE	280543
BLACK	280544



**CEILING BASE Ø200
3 PENDANTS**

WHITE	280530
BLACK	280531



**CEILING BASE Ø300
7 PENDANTS**

WHITE	280533
BLACK	280534



**CEILING BASE Ø400
11 PENDANTS**

WHITE	280536
BLACK	280537



CEILING BASE Ø400 / Black / DROP S1 / DROP S2 / Rese Gold

DOWNLIGHTS



ANGLE

Product Specs

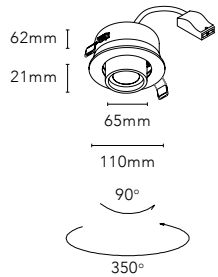

ANGLE

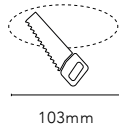

Designer

Ronni Gol

Technical Info

LED | DIMMABLE | IP21* | INDOOR USE | SWITCH TUNE*

*ANGLE in black (270511 and 261663) are only available in IP20 and does not have the SWITCH TUNE function.

SWITCH TUNE gives you the option to choose between 2700K or 3000K before installing the lamp.

Colour Options

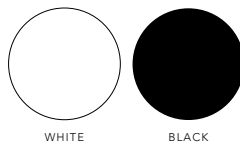





ANGLE

7W LED | 230V | IP21* | CRI >90 |
Lumen 594lm

WHITE 2700/3000K	270512
BLACK 2700/3000K	270513

SWITCH  **TUNE**™





CURVE

Product Specs

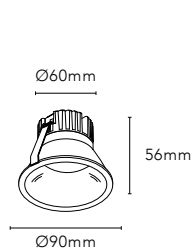

CURVE II Ø90

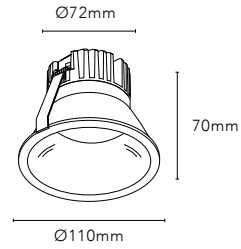
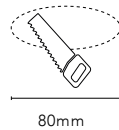

CURVE II Ø110

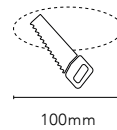

Designer

Ronni Gol

Technical Info

LED | DIMMABLE | IP54 | INDOOR USE | OUTDOOR USE | SWITCH TUNE

SWITCH TUNE gives you the option to choose between 2700K or 3000K before installing the lamp.

Colour Options

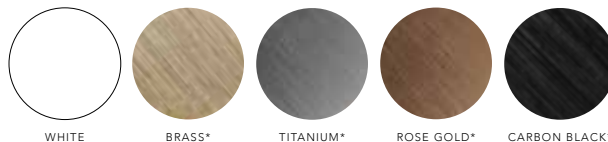

*Anodized surfaces may vary $\pm 10\%$ and are not recommended for outdoor use.



CURVE / Brass
SOHO W1 / SOHO W2 / Brass



CURVE II Ø90

8W LED | 230V | IP54 | CRI >90 | Lumen
780lm

BRASS <small>2700/3000K</small>	270944
TITANIUM <small>2700/3000K</small>	270943
ROSE GOLD <small>2700/3000K</small>	270942
CARBON BLACK <small>2700/3000K</small>	270941
WHITE <small>2700/3000K</small>	270940

SWITCH  TUNE™



CURVE II Ø110

15W LED | 230V | IP54 | CRI >90 | Lumen
1115lm

BRASS <small>2700/3000K</small>	270949
TITANIUM <small>2700/3000K</small>	270948
ROSE GOLD <small>2700/3000K</small>	270947
CARBON BLACK <small>2700/3000K</small>	270946
WHITE <small>2700/3000K</small>	270945

SWITCH  TUNE™



GHOST

Product Specs

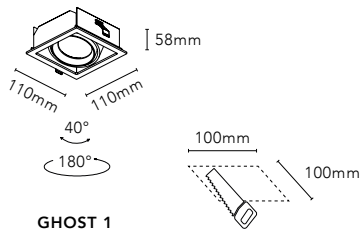

GHOST 1

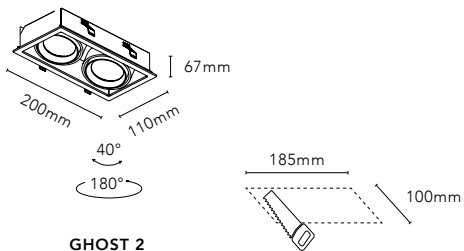

GHOST 2

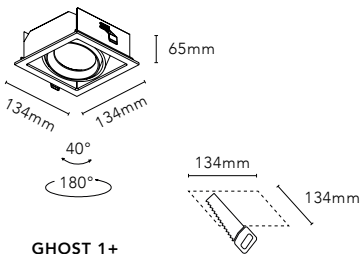

GHOST 1+

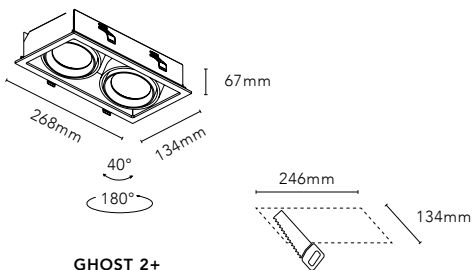

GHOST 2+

Designer

Ronni Gol

Technical Info

LED | DIMMABLE | IP20 | INDOOR USE | SWITCH TUNE

SWITCH TUNE gives you the option to choose between 2700K or 3000K before installing the lamp.

Colour Options

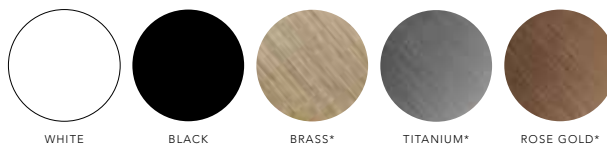

*Anodized surfaces may vary $\pm 10\%$ and are not recommended for outdoor use.

WHITE

BLACK

BRASS*

TITANIUM*

ROSE GOLD*





GHOST 1

6W LED | 230V | IP20 | CRI >90 |
Lumen 300lm

BRASS 2700/3000K	270844
TITANIUM 2700/3000K	270843
ROSE GOLD 2700/3000K	270842
WHITE 2700/3000K	270840
BLACK 2700/3000K	270841

SWITCH  TUNE™



GHOST 2

2x6W LED | 230V | IP20 | CRI >90 |
Lumen 600lm

BRASS 2700/3000K	270854
TITANIUM 2700/3000K	270853
ROSE GOLD* 2700/3000K	270852
WHITE 2700/3000K	270850
BLACK 2700/3000K	270851

SWITCH  TUNE™



GHOST 1+

9W LED - 230V - IP20 - CRI >90 |
Lumen 495lm

TITANIUM 2700/3000K	270863
ROSE GOLD 2700/3000K	270862
WHITE 2700/3000K	270860
BLACK 2700/3000K	270861

SWITCH  TUNE™



GHOST 2+

2x9W LED | 230V | IP20 | CRI >90 |
Lumen 990lm

TITANIUM 2700/3000K	270873
ROSE GOLD 2700/3000K	270872
WHITE 2700/3000K	270870
BLACK 2700/3000K	270871

SWITCH  TUNE™





MIRAGE

Product Specs

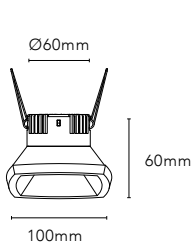

MIRAGE 1

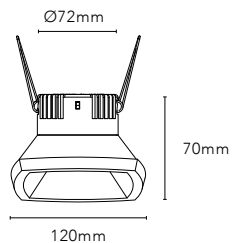

MIRAGE 2

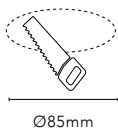

Ø85mm

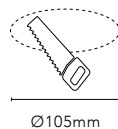

Ø105mm

Designer

Nital Patel

Technical Info

LED | DIMMABLE | IP54 | INDOOR USE | OUTDOOR USE | SWITCH TUNE

SWITCH TUNE gives you the option to choose between 2700K or 3000K before installing the lamp.

Colour Options

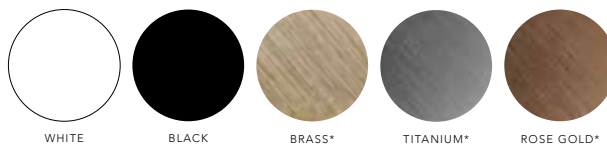

*Anodized surfaces may vary $\pm 10\%$ and are not recommended for outdoor use.





MIRAGE 1

10W LED - 230V - IP54 - CRI >90
Lumen 820lm (nominal)

BRASS <small>2700/3000K</small>	271024
TITANIUM <small>2700/3000K</small>	271023
ROSE GOLD <small>2700/3000K</small>	271022
WHITE <small>2700/3000K</small>	271020
BLACK <small>2700/3000K</small>	271021

SWITCH  **TUNE™**



MIRAGE 1+

15W LED - 230V - IP54 - CRI >90
Lumen 1162lm (nominal)

BRASS <small>2700/3000K</small>	271029
TITANIUM <small>2700/3000K</small>	271028
ROSE GOLD <small>2700/3000K</small>	271027
WHITE <small>2700/3000K</small>	271025
BLACK <small>2700/3000K</small>	271026

SWITCH  **TUNE™**





OPTIC IN

Product Specs

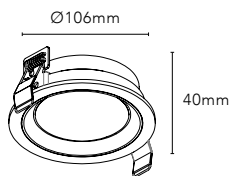

OPTIC IN 1

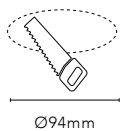

Designer

Nital Patel

Technical Info

LED | DIMMABLE | IP54 | INDOOR USE | OUTDOOR USE

Including 3 changeable colour rings: Black, White and Gold.

Colour Options

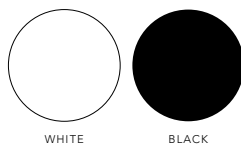





OPTIC IN 1

6W LED | 230V | IP54 | CRI >90 |
Lumen 540lm (nominal)

WHITE 2700K	270320
BLACK 2700K	270321



OPTIC IN 1 / White

General terms of sale and delivery

The following terms and conditions cover all deliveries and services from LIGHT-POINT A/S, unless other terms have been agreed upon in writing.

Tender

A tender is binding for three weeks from the date of the tender.

Dispatch/return of goods

Delivery will be EXW LIGHT-POINT A/S' warehouse (Incoterms 2000) unless other terms have been explicitly agreed upon. When buying any of LIGHT-POINT A/S' goods for resale buyer shall defray all freight charges himself.

Dispatch will take place at buyers' own account and risk. When delivery has been agreed to be free of carriage the cost of dispatch is included in the price and the dispatch will be at the risk of LIGHT-POINT A/S. Buyer is only entitled to annul the order due to delay provided delivery is delayed for more than 30 days.

Returned goods will only be received when prior agreement of return has been reached and then only in the original wrapping and in an undamaged state. A copy of the delivery note or the invoice must accompany the returned goods.

Erroneous orders for standard goods will be deducted 20% for handling and control. Special goods, procured goods and unwrapped light sources will not be accepted for return.

Prices

All prices are current prices exclusive VAT, government taxes and light sources unless otherwise stated. All prices are stated without prejudice to printing errors, price changes and discontinued goods.

Payment

Unless otherwise stated in LIGHT-POINT A/S' tender or other written agreement our terms of payment are net cash at delivery/collection. At delay in payment a fee of DKK 100.00 and interest of 2% per commencing month will be added.

Notification of defects

Buyer is obligated to examine the goods immediately after receiving them. Notification of defects must be given to LIGHT-POINT A/S within 8 days of delivery. If buyer does not notify LIGHT-POINT A/S of defects within this time-limit he will not be able to cite any defects at a later date. Expenses incurred by buyer in con-

nection with cited defects are not covered by LIGHT-POINT A/S unless LIGHT-POINT A/S has received the notification of defects and has given a written acceptance to cover the costs.

Warranty

Products which have a manufacturing fault or a flaw in the material will be repaired without cost or exchanged in accordance with the rules in the Danish Sale of Goods Act and to the same extent that the warranty from sub suppliers covers. Light sources are not covered by warranty.



Scan the QR-code and read more about our 7 years warranty.

Exemption of liability

Non-fulfilment including delay or delivery of defective goods will only justify buyer compensation provided buyer documents that the non-fulfilment is caused by gross negligence on the part of LIGHT-POINT A/S. However LIGHT-POINT A/S is in no case responsible

for operating loss, loss of time, loss of profits or other like indirect losses including daily fines inflicted on buyer.

Product liability

The company is only responsible for product liability in accordance to the rules in the Danish Product Liability Act. Beyond this the company is not responsible for product liability.

Disputes

Disagreements in connection with the cooperation of the parties with reference to this agreement must be solved according to Danish law, in as much as the parties agree that the venue shall be the Maritime and Commercial High Court in Copenhagen or alternatively the City Court of Copenhagen.

Copenhagen K, 1st of September 2024.

LIGHT·POINT
C O P E N H A G E N

info@light-point.com | www.light-point.com
#lightpointcom | @lightpointcom

LIGHT-POINT is a registered trademark
of NORDIC LIVING GROUP.

LIGHT-POINT | Stores & Showrooms

Gothersgade 14, 1123 Copenhagen K., Denmark
Falkoner Allé 29, 2000 Frederiksberg, Denmark

LIGHT-POINT | Headquarters

Grønnegade 3, 1107 Copenhagen K., Denmark

© LIGHT-POINT 2025. All rights reserved.

LIGHT-POINT believes that all information in this publication is correct at the time of printing, but is not responsible for accuracy of information published.

All information is subject to change without notice.



™

FSC
www.fsc.org

MIX

Paper | Supporting
responsible forestry

FSC™ C112664

LIGHT·POINT®

C O P E N H A G E N



Gothersgade 14
1123 Copenhagen K
Denmark

Falkoner Allé 29
2000 Frederiksberg
Denmark

LIGHT-POINT.COM